

CJPP

CR-22P



USER MANUAL

TABLE OF CONTENTS

1.	INTRODUCTION	1
2.	INTENDED USE	1
3.	FEATURES	1
4.	STANDARD ACCESSORIES	1
5.	TECHNICAL SPECIFICATION	1
6.	SAFETY PRECAUTION	2
7.	INSTALLATION	3
8.	STANDARD PARTS LISTING	5
9.	USER INTERFACE & DISPLAY	6
10.	ROTOR INSTALLATION	6
11.	BALANCING THE ROTOR	7
12.	OPERATING THE CENTRIFUGE	8
13.	TROUBLESHOOTING	10
14.	WARRANTY STATEMENT	11
15.	PRODUCT DISPOSAL	12

1. INTRODUCTION

This is a microprocessor controlled next generation digital 96/384 well micro-plate Centrifuge. This centrifuge is designed for the separation and preparation of samples in various applications including Molecular biology, Genetic engineering, microbiology, genomics, immunology, in-vitro diagnostic etc. This product is equipped with maintenance-free Brushless DC motor drive and safety feature of imbalance detection. It is also compatible with different types of microplates of standard size.

2. INTENDED USE

This bench top 2 placed microplate centrifuge is designed for PCR plates, ELISA plate, Cytokine assay plate, quantifications of samples, short spin downs at various molecular biology/genomics labs, proteomics labs, diagnostic labs, forensic laboratories and hospitals for routine plate centrifuging application.

NOTE: Before using the instrument, please read this user manual carefully. This user manual is intended to assist with the operation and care of the unit only and not its repair. For repair please contact the supplier.

3. FEATURES

- Brushless DC motor for maintenance free long life
- Microprocessor controlled: Enables digital variable speed and time setting with last run memory function
- Single instrument for different work protocols with appropriate choice of rotors
- Precise RPM setting from 500 to 2500 RPM with least count of 100 RPM
- Automatic imbalance detection for safe operation
- Lid lock safety - Lid releases (automatically) after run completion
- Compact design with low loading height for ease of operation
- P1 & P2 defined program features

4. STANDARD ACCESSORIES

- Power Adaptor: Input voltage - 100-240V, 50/60Hz
Output voltage: 24V  1.5A
- T-Allen Key
- Rotor
- Product user manual & warranty card

5. TECHNICAL SPECIFICATION

Motor Type	Brushless Motor
Maximum Volume	2 micro plate (96 & 384 well)

5. TECHNICAL SPECIFICATION

Speed Setting	2500 RPM
	462 g (Max RCF)
Speed Accuracy	± 100 RPM
Run time	1 to 99 mins & infinite mode
Acceleration Time	30 + 5 seconds
Deceleration Time	20 + 5 seconds
Dimensions (W x D x H)	330 x 265 x 161 mm
Weight	4 Kg (without rotor)
Humidity	80%
Input Voltage	24V $\overline{\text{---}}$ 1.5A
Power Consumption	24 W

6. SAFETY PRECAUTIONS

- Never use the centrifuge in any manner not specified in this manual.
- Equipment used in any manner not specified in this manual or by the manufacturer can result in the lapse of warranty. 
- Never move the centrifuge during its operation.
- The rotor and the rotor only must always be securely fastened. If the centrifuge makes unusual noise during operation, the rotor or the rotor lid fitment needs to be checked. Switch OFF the device immediately by pressing STOP, check fitment & fasten it (if required).
- The rotors must be loaded symmetrically. Each plates should be counter balanced by another plates of same weight.
- Do not use centrifuge or rotor that have not been correctly installed or damaged.
- Repairs must only be performed by authorized service technician.
- Only use recommended original rotors and spare parts for best result & product safety.
- Centrifuge must be used for the specified application only. It must not be operated in a hazardous or flammable environment and must not be used to centrifuge explosive or highly reactive media. Also do not place the potential hazardous material within the clearance area/envelope.
- If liquids are spilled on the rotor or rotor chamber, the centrifuge must be cleaned carefully and properly before being used again.
- Prior to centrifugation, the plates should be visually inspected for material damage. Damaged plates must not be used. This is because broken plates can result in sample loss and in addition can create imbalance which can result in further damage to the centrifuge and its accessories.
- This centrifuges capacity must not be exceeded as it is the maximum capacity.

6. SAFETY PRECAUTIONS

- Do not lean on the equipment. It may damage the equipment or the harm the operator.
- When moving the centrifuge from a cold room to a normal room, run the centrifuge for 30 minutes beforehand in the cold room to avoid condensation. Alternately, allow it to warm up in lab for at least three hours, but do not plug in the centrifuge in order to prevent possible damage by condensation.
- Be sure to close the plates lid tightly prior to centrifugation. Open plates lid can be torn off during centrifugation and can damage the rotor lid or centrifuge.
- Rotor and adapters are high-graded components which are subject to extreme mechanical strain. Even slight scratches and tears can lead to serious internal material damage. Ensure to check rotor for any signs of damage before use. Rotor & rotor lid showing visible signs of corrosion or mechanical damage should not be used.
- Do not fill plates while they are in the rotor. Liquid spillage may harm the device.
- For safety we have provided protective earthing with power supply. Make sure power supply is earthened.
- In the event of contamination caused by aggressive agents, the rotor must be cleaned immediately using a natural cleaning liquid. If any kind of damage is seen kindly contact the service technician.
- Before using cleaning or decontamination method other than those mentioned by the manufacturer, contact the manufacturer to ensure that the intended method will not damage the centrifuge.
- The power adaptor given with centrifuge unit is designed to be used for this particular centrifuge only. Do not use any other power adaptor.

NOTE: Make sure to insert both micro plates for balancing the rotor and reduce vibrations.

7. INSTALLATION

This centrifuge comes in a packaging box. On receiving the box, gently remove the upper packaging and take out the centrifuge by holding it from the bottom. When centrifuge is used for the first time, ensure that all the packaging accessories are removed from the rotor chamber. The rotor is pre-installed and please make sure that rotor is firmly tightened. Accessories and user manual are kept inside the box with centrifuge. Please keep all the packaging in safe storage for at least 2 years for warranty purpose.

NOTE: Instruction for transportation after delivery to the Responsible Body is based in deal to customer.

The following points are necessary to take care for proper installation:

7. INSTALLATION

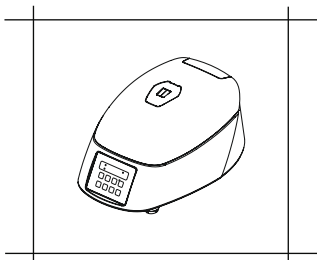

Must be used on Flat & Non - Slippery Surface

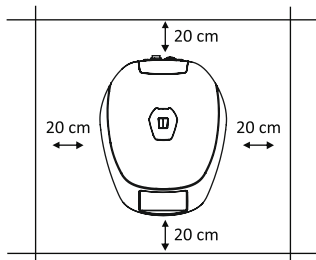

Must have Clearance of 20 cm from all 4 sides

LOCATION & MOUNTING

Place the centrifuge on a flat and leveled surface; ensure that all the four feet of this centrifuge stands on the surface firmly. Avoid installing on a slippery surface or surface prone to vibration.

1. Ideal ambient temperature is $20^{\circ}\text{C} \pm 5^{\circ}\text{C}$; avoid placing the centrifuge in direct sunlight.
2. Keep clearance of at least 10 cm on both sides and at least 30 cm behind it to guarantee the cooling efficiency.
3. Keep away from heat or water to avoid sample temperature issues or centrifuge failures.
4. Do not place the centrifuge so that it become difficult to operate the device.

CONNECTING POWER ADAPTOR

1. Connect one side of power adaptor to rear side of centrifuge and other to supply as shown in the figure below.
2. Rotate clockwise the adaptor nut to tighten the adaptor with the centrifuge. Ensure the power switch is OFF while connecting the power adaptor.
3. The sticker on the body & jack are indicating the position of the rib on the jack. While fitting the adaptor to the unit-please match the sticker position as shown in the figure below & gently push it in.

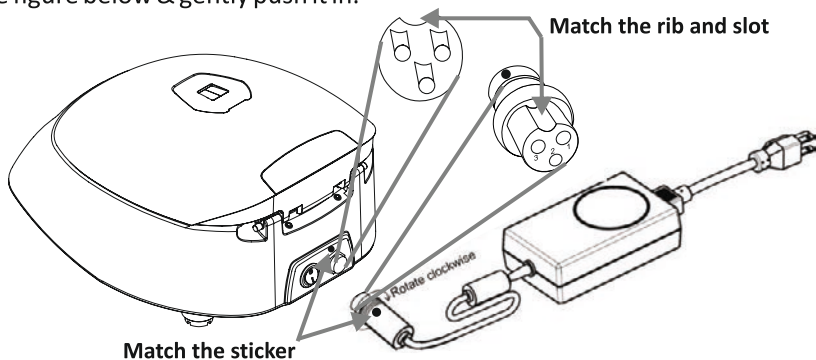

7. INSTALLATION

4. If matched correctly the plug will go in easily without much force (do not try to force the plug in if it is not matched properly). Once the plug is inserted into position, turn the loose upper ring clockwise to tighten & to secure the fitment.

8. STANDARD PARTS LISTING

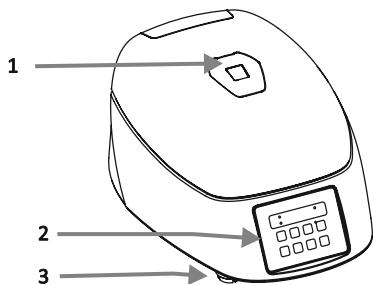

1. View Window
2. Operation and setting Buttons & Display
3. Emergency Lid Release

Front View

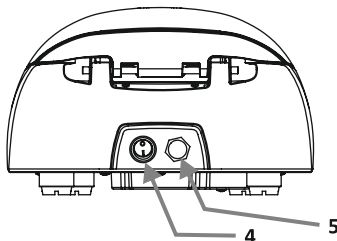

4. Power Switch
5. Adaptor Port

Rear View

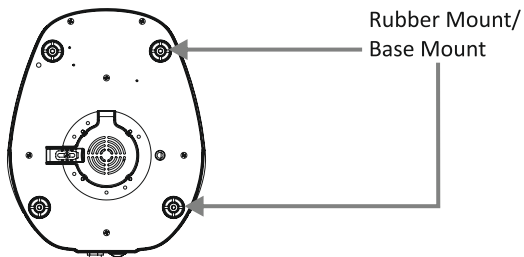

Bottom View

9. USER INTERFACE & DISPLAY

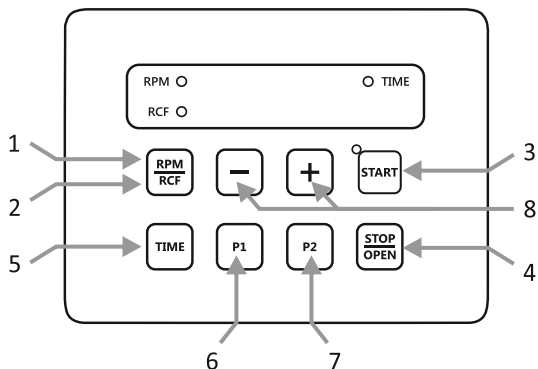

Item	Name	Function
1	RPM	Press this button to select RPM value. Then Press “+/-” to set RPM value.
2	RCF	Long press “RPM/RCF” to toggle between RPM/RCF value. Select the RCF value to be set for centrifugation.
3	START	Single press “START” button centrifuge will start as per set RPM and TIME. START button works only if lid is closed.
4	STOP/OPEN	Single press “STOP/OPEN” button will stop centrifuge. Centrifuge lid will open automatically after end of centrifugation.
5	TIME	Press this button to select Time value. Then Press “+/-” to set Time value.
6	P1	Single press “P1” button to set program mode.
7	P2	Single press “P2” button to set program mode.
8	+/-	“+” is used to increase and “-” is used to decrease values.

10. ROTOR INSTALLATION

ROTOR REMOVING AND REPLACING PROCESS

Upon receiving this centrifuge, its rotor comes pre-installed. In case if user wants to remove or replace rotor, follow the below mentioned procedure :

REMOVING ROTOR

1. Do not try remove or loosen the rotor with bare hands.
2. Using T - Allen Key, loosen the rotor nut by turning it anti-clockwise.

10. ROTOR INSTALLATION

REPLACING ROTOR

1. To replace or install the rotor, take rotor and load vertically on the motor shaft.
2. Place the rotor nut in the center hole of the rotor onto the motor shaft.

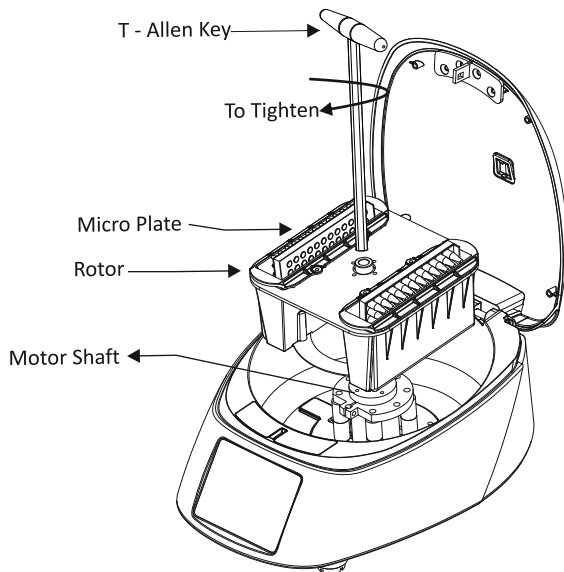

3. Put T-Allen Key in rotor nut & turn clockwise to tighten and anticlockwise to loosen rotor.

NOTE: Check the rotor is firmly tightened before running.

11. BALANCING THE ROTOR

1. Always balance the rotor before beginning the operation. Following are the process of symmetrical loading of centrifuge plates in the rotor.

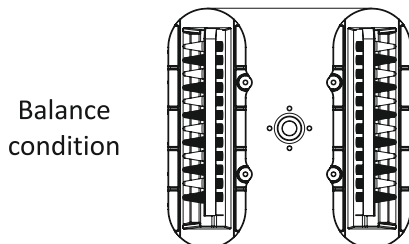

11. BALANCING THE ROTOR

2. The above is the method to load the plates symmetrically in the rotor. The most important point to remember is that samples in the plates should be of equal volumes.
3. Symmetrical loading of plates in the rotor is necessary. Otherwise vibration or imbalance can occur which can cause serious damage to the centrifuge & user.
4. If the plates are not loaded symmetrically then the imbalance detector will cut off the running centrifuge for the safety of device & user. This will stop the centrifuge and Err 55 will be seen indicating plates are not loaded symmetrically. To resume operation, load plates symmetrically & restart the centrifuge.
5. Incorrect method of loading plates in centrifuge rotor.

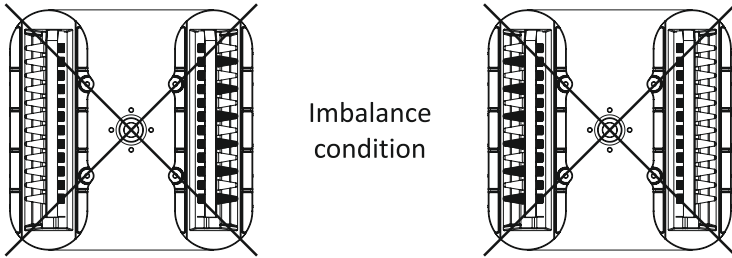

NOTE: 1) incorrect method of loading plates can lead to an accident.
2) "Plates Holder" are the part of Rotor.

12. OPERATING THE CENTRIFUGE

SWITCH ON THE CENTRIFUGE

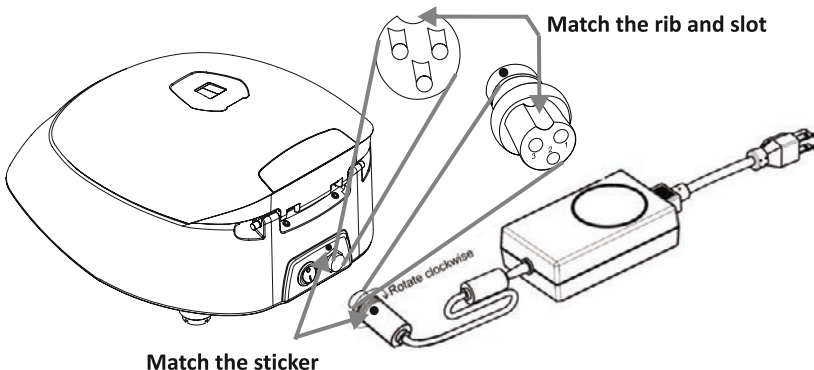

12. OPERATING THE CENTRIFUGE

After connecting the power adaptor, switch ON the main power supply & the switch at the rear side of the centrifuge. Make sure to check the rotor fitment before use. Centrifuge will not operate with open lid.

NOTE: Maintain a gap of 3 seconds between switch OFF and switch ON again. DO NOT switch OFF and ON again instantly.

SPEED SETTING

After closing the centrifuge lid, press “RPM/RCF” button to select speed setting in RPM/RCF mode. Now press “+” button to increase the speed value and press “-” button to decrease the speed value. Minimum and maximum RPM of the centrifuge is 500 rpm to 2500 rpm respectively. Upon Centrifugation the flashing signal of RPM value will stop and the same value will be stored automatically, if no button is pressed after around 1 seconds of the adjustment.

The speed can also be changed while the centrifuge is under operation. Press the “RPM/RCF” button & use setting (+) and (-) to change speed. Changing the speed between the ongoing Centrifugation will cause it to run at updated speed for the remaining time as indicated by the timer. The RCF & RPM toggle is also present. Long Press “RPM/RCF” button to change the RCF setting. Press the (+) & (-) button to increase or decrease the value. The flashing of RCF value will stop and the RCF value will be stored automatically if no button is pressed after around 1 seconds of the adjustment. The value will blink 5 time to indicate acceptance.

TIME SETTING

Operating time can be selected from 1 min to 99 min or “continuous”. Press “TIME” button to change the time setting. Press the “+” and “-” button to increase or decrease the value. The value will blink 5 time to indicate acceptance. . The timing for run can be set from 1min to 99 minutes or operated in infinite time mode. Infinite timer will be indicated by][:] in display. The timer in the centrifuge is countdown timer with display of “Min/Sec” mode.

START AND STOP OPERATION SETTING

Press “START” button to start operation and press “Stop” button to stop the ongoing operation, the same would be indicated by the LED light. Once operation is stopped the lid is opened automatically.

PROGRAM MODE & LINE SETTING

Single press “P1” button to enter into program mode. and Press “RPM/RCF” Button to change in RPM/RCF in program mode. and select to “+” and “-” button to change RPM/RCF value and press “TIME” button to change in time in program mode. Values that would be set for any parameter gets saved after 5 blinks. Once program is set,

12. OPERATING THE CENTRIFUGE

press “START” button to start program. Single press “P1” button to enter into only one program. and use second program to press “P2” button. By default P1 & P2 program will have zero (0) values and once the “P1” button is pressed below display will appear indicating P1 & if long press is done to “P1” or “P2” button the centrifuge enters back to the normal mode.

CHANGING THE SETTING DURING A RUN

Users can change the settings while the rotor is running. Through a one-time pressing of any function buttons (TIME, RPM, RCF), the current value will switch into the preset value mode. The new value can be set once function flashes. Once the display switches into the current value mode after completion of the entered values, the new values are activated. The new values are stored and executed by pressing the function button which is notified by 5 time blink to indicate acceptance.

OPENING CENTRIFUGE LID IN POWER FAILURE

Disconnect the centrifuge from the main supply. Wait until the rotor comes to a stop (this may take some time). Once the rotor has stopped, pull out the emergency lid release as shown in the figure. This will open the centrifuge lid. After the centrifuge lid opens, push the thread back in the hole with your hand and fit the emergency release cap back in the hole.

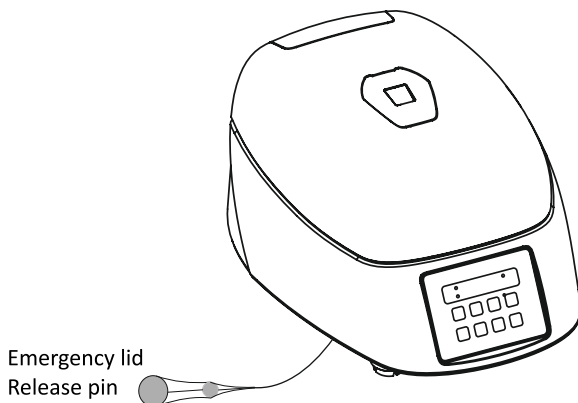

13. TROUBLESHOOTING

This centrifuge has a self – diagnostic function. If a problem occurs, an error/warning code will be displayed on the display screen and the operator can determine the malfunction with the warning code below.

13. TROUBLESHOOTING

ERROR	PROBLEM	SOLUTION
No display	No main power connection	Check power & properly plugin power adaptor at both ends
	Power failure	Check the main fuse of the lab.
	Improper connection	Connect adaptor properly
Err 1	Latch jammed or any limit switch of latch got damaged.	Contact service representative.
Err 52	Rotor stuck or incorrect operating voltage.	Turn off the centrifuge, check rotor fitment or apply correct 230 VAC \pm 10VAC operating voltage. restart unit
Err 55	Rotor not loaded symmetrically	Load the rotor symmetrically & restart the centrifuge
Centrifuge lid cannot be opened	Rotor is still spinning	Wait for the rotor to come to a stop
	Power failure	Press emergency lid release after rotor stops
Centrifuge shakes during acceleration & exceptional running noise	Rotor is not loaded symmetrically	Load rotor symmetrically & restart operation
	Either a broken plates, damage to the rotor or motor is the cause for run noise	Replace broken plates. For damaged rotor/motor contact a service representative
	Rotor is damaged	Remove & change rotor
Display Error	Loose connection of display	Contact service representative
Power tripping	Cable not fit properly	Remove cable and connect properly

NOTE: 1) If the centrifuge is working slow or hot due to overdraw current, restart the centrifuge and check it again.

2) Do not use liquid with density higher than 1.2g/ml for full load operation.

14. WARRANTY STATEMENT

This product is warranted to be free from defects in material and workmanship for a period of two (2) years from date of purchase. Your product will be duly repaired upon prompt notification in compliance with the following conditions :

This warranty is valid only if the product is used for its intended purpose and within the guidelines specified in this instruction manual. This warranty does not cover damage caused by accident, neglect, misuse, improper service, natural forces or

14. WARRANTY STATEMENT

other causes not arising from defects in original material or workmanship. This warranty does not cover any incidental or consequential damages, commercial loss or any other damages from the use of this product.

The warranty is invalidated by any non-factory modification, which will immediately terminate all liabilities on us for the products or damages caused by its use. The buyer and its customer shall be responsible for the product or use of products as well as any supervision required for safety. If requested the products must be returned to the distributor in well packed and insured manner and all shipping charges must be paid.

Some states do not allow limitation on the length of implied warranties or the exclusion or limitation of incidental or consequential damages. This warranty gives you specific legal rights. This warranty is given expressly in lieu of all other warranties, expressed or implied.

The purchaser agrees that there is no warranty of merchantability or of fitness for any intended purpose and that there are no other remedies or warranties, expressed or implied, which extend beyond the description on the face of the agreement. This warranty is only applicable to the original purchaser.

Products received without proper authorization will not be entertained. All items returned for service should be sent postage prepaid in the original packaging or other suitable carton, padded to avoid damage.

We will not be responsible for damage incurred by improper packaging.

All items returned for service should be set postage prepaid in the original packaging or other suitable carton, added to avoid damage.

This warranty is valid only if the warranty is registered with the supplier within 30 days from the date of purchase.

For your reference, make a note of serial number, date of purchase and supplier here.	
Serial No.:	Purchase Date:
Supplier:	

15. PRODUCT DISPOSAL

In case the product is to be disposed of, the relevant legal regulations are to be observed.

Information on the disposal of electrical and electronic devices in the European Community.

15. PRODUCT DISPOSAL

The disposal of electrical devices is regulated within the European Community by national regulations based on EU Directive 2012/19/EU on waste electrical and electronic equipment (WEEE). According to these regulations, any devices supplied after 13.06.05 in the business to business sphere, to which this product is assigned, may no longer be disposed off in municipal or domestic waste. They are marked with the following symbol to indicate this.

As disposal regulations within the EU may vary from country to country, please contact your supplier if necessary.





AHN Biotechnologie GmbH

Uthleber Weg 14
D-99734 Nordhausen
Germany

Phone: +49(0)3631/65242-0

Fax: +49(0)3631/65242-90

E-Mail: info@cappahn.com
www.capp.dk