

CAPP

CR-1512



USER MANUAL

CONTENTS

1.	INTRODUCTION	1
2.	INTENDED USE	1
3.	PRODUCT FEATURES	1
4.	ACCESSORIES	2
5.	TECHNICAL SPECIFICATIONS	2
6.	SAFETY PRECAUTIONS	2
7.	INSTALLATION	4
•	MOUNTING	
•	CONNECTING POWER ADAPTOR	
8.	STANDARD PARTS LISTING	5
9.	USER INTERFACE AND DISPLAY	5
10.	ROTOR INSTALLATION	7
•	ROTORS AND ACCESSORIES	
•	ROTOR REMOVING & REPLACING PROCESS	
•	BALANCING THE ROTOR	
11.	OPERATING THE CENTRIFUGE	8
•	STARTING THE CENTRIFUGE	
•	SETTING SPEED AND TIME	
•	SWITCHING TO RCF DISPLAY	
•	SHORT SPIN CENTRIFUGATION	
•	OPENING CENTRIFUGE LID IN POWER FAILURE	
•	IMBALANCE DETECTION	
12.	REMOTE OPERATION & PROGRAMMING	10
•	SYSTEM REQUIREMENT	
•	INSTALLING GUI SOFTWARE	
•	CONNECTING USB CABLE	
•	UNDERSTANDING THE GUI AND ITS OPERATION	
•	DATA LOG	
13.	MAINTENANCE AND CLEANING	16
14.	TROUBLESHOOTING	17
15.	WARRANTY STATEMENT	18
16.	PRODUCT DISPOSAL	19

1. INTRODUCTION

This manual provides important safety information for this centrifuge. It should be kept near the centrifuge for quick & easy reference. This centrifuge is equipped with a maintenance free drive, a large display & a simple interface for silent & efficient operation in the lab. This microcentrifuge can be operated via USB with facility of data logger and comes with a host of safety features including imbalance detection. This microcentrifuge is fully programmable & can deliver up to 15000 RPM. It is designed to work with variety of microtubes ranging from 0.1ml to 2ml. This comes with 2 rotors, one for 12 x 1.5/2ml tubes & the other for 2 x8 PCR tube strips.

2. INTENDED USE

This microcentrifuge is designed to be used in a laboratory to separate particles from suspension or even macromolecules from solutions according to their density. The different biological substances that are usually separated by centrifugation are microbial cells, mammalian cells, organelles, proteins, DNA and RNA. It is widely used in research laboratories.

NOTE: *Before using the centrifuge, please read this user manual carefully. This user manual is intended to assist with the operation and care of the unit only and not its repair. For repair please contact the supplier.*

3. PRODUCT FEATURES

1. Imbalance detector with auto cutoff.
2. Large back lit digital LCD display.
3. Maximum speed of 15000 RPM/15596 xg RCF.
4. USB port for remote terminal control capability.
5. Remote operation with data log.
6. Lid safety interlock and auto lid open
7. Convenient and easy user interface.
8. Quick acceleration and deceleration time.
9. One touch short spin centrifugation.
10. Last run memory feature.
11. Emergency lid release during power cutoff.
12. Countdown timer.
13. Automatic internal diagnosis and error display.
14. Speed setting by RPM/RCF mode.
15. Fully autoclavable high strength aluminum rotor with metal lid.
16. Small footprint.

4. ACCESSORIES

- USB cable & T - Allen wrench
- 12 slots microtube rotor (Pre-installed) and *2 x 8-0.1/0.2ml PCR strip rotor*
- Adaptors for 0.4/0.5 ml tubes (set of 12)
- Adaptors for 0.1/0.2 ml tubes (set of 12)
- Software CD, 7.Product user manual and warranty card
- Power Adaptor: Input voltage-100-240VAC 50/60Hz

Output voltage: 24V  6.25A

Note: Has to be ordered separately (optional accessory)

5. TECHNICAL SPECIFICATIONS

Motor Type	Brushless DC Motor
Rotor Capacity	12 x 2 ml (microtubes)
Speed Setting	Variable 500 - 15000 RPM
	15596 x g (Max RCF)
Speed Accuracy	± 100 RPM
Run Time	30 secs to 999 mins & infinite mode
Acceleration Time	30 seconds
Deceleration Time	40 seconds
Noise Level	<60 dB
Ambient Temperature	5 - 40 °C
Permissible Relative Moisture	<80%
Size (W x D x H)	262 x 230 x 131 mm
Weight	4.5 Kg (with rotor)
Input Power	24V  3A
Power Consumption	72W

6. SAFETY PRECAUTIONS

- Never use the centrifuge in any manner not specified in this manual.

- Using equipment in any manner not specified in this manual or by the manufacturer, will void the warranty.
- Never move the centrifuge while the rotor is spinning.
- The rotor and the rotor lid must always be securely fastened. If the centrifuge makes unusual noise during operation, the rotor or rotor lid should be checked. Switch OFF the device immediately by pressing STOP, check rotor fit & fasten it well.
- The rotors must be loaded symmetrically. Each tube should be counter balanced by another tube of the same weight.
- Do not use the centrifuge or rotor that have not been correctly installed or damaged.
- Repairs must only be performed by authorized service technician.
- Using incorrect rotors & wrong spare parts will void the warranty.
- Centrifuge may be used for the specified applications only. It must not be operated in a hazardous or flammable environment and must not be used to centrifuge explosive or highly reactive substances.
- If liquids are spilled on the rotor or rotor chamber, the centrifuge must be cleaned carefully and properly before being used again.
- Prior to centrifugation, the tubes should be visually inspected for material damage. Damaged tubes may not be centrifuged. This is because broken tubes can, in addition to sample loss, create imbalance which can result in further damage to the centrifuge and accessories.
- The capacity of 12 x 1.5 / 2 ml must not be exceeded as it is the maximum capacity. Do not use liquid with density higher than 1.2g/ml for full load operation.
- Do not lean on the equipment. It may damage the equipment or the harm the operator.
- When moving the centrifuge from a cold room to a normal room, run the centrifuge for 30 minutes beforehand in the cold room to avoid condensation. Alternately, allow it to warm up in the lab for at least 3 hours before use, but do not plug in the centrifuge in order to prevent possible damage by condensation.
- Be sure to close the tubes lid tightly prior to centrifugation. Open tubes lid can be torn off during centrifugation and can damage the rotor lid or centrifuge.
- Rotors and rotor lids are high-graded components which are subject to extreme mechanical strain. Even slight scratches and tears can lead to serious internal material damage. Ensure to check the rotor for any signs of damage before use. Rotor & rotor lid showing visible signs of corrosion or mechanical damage should not be used, contact your local supplier or mfg for replacement rotor & parts.
- Do not fill tubes while they are in the rotor. Liquid spillage may harm the device.
- In the event of contamination caused by aggressive agents, the rotor must be



cleaned immediately using a natural cleaning liquid (like water). This is particularly important for the bores of the tubes. If any damage is seen, contact the service technician.

- Before using cleaning or decontamination methods, other than those stipulated by the manufacturer, contact the manufacturer to ensure that the intended method will not damage the centrifuge.
- The power adaptor given with centrifuge unit is designed to use with that particular centrifuge. Do not use any other power adaptor, using any other power adaptor may damage the centrifuge and will void the warranty.

7. INSTALLATION

Open the box, then remove the packaging and gently take the centrifuge out of the box. Before using this centrifuge open the centrifuge & remove all packaging from the rotor chamber & ensure rotor is firmly tightened. The user manual and accessories should be kept near the centrifuge. Please keep all packaging in safe storage for at least 2 years for warranty purpose.

• MOUNTING

Place the centrifuge on a flat and leveled surface; ensure that the four feet of this centrifuge stand on the surface firmly. Avoid installing on a slippery surface or surface prone to vibration.

1. Ideal ambient temperature is $20^{\circ}\text{C} \pm 5^{\circ}\text{C}$; avoid placing the centrifuge in direct sunlight.
2. Keep clearance of at least 10 cm on both sides and at least 30 cm behind it to guarantee cooling efficiency.
3. Keep away from heat or water to avoid sample temperature issues or centrifuge failures.
4. Do not place the centrifuge in any area where operating the unit maybe difficult.

• CONNECTING POWER ADAPTOR

1. Connect one side of power adaptor to rear side of centrifuge and the other side to supply as shown in the figure below.
2. Rotate clockwise the adaptor nut to tighten the adaptor with the centrifuge. Ensure the power switch is OFF while connecting the power adaptor.
3. The sticker on the body & jack are indicating the position of the rib on the jack. While fitting the adaptor to the unit please match the sticker position as shown in the figure below & gently push it in.

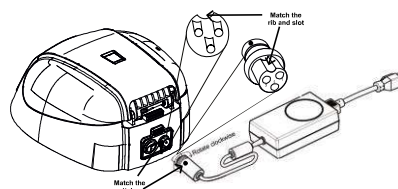

4. If matched correctly the plug will go in easily without much force (do not try to force the plug in if it is not matched properly). Once the plug is inserted into position, turn the loosened upper ring clockwise until it is tight to secure the fitment.

8. STANDARD PARTS LISTING

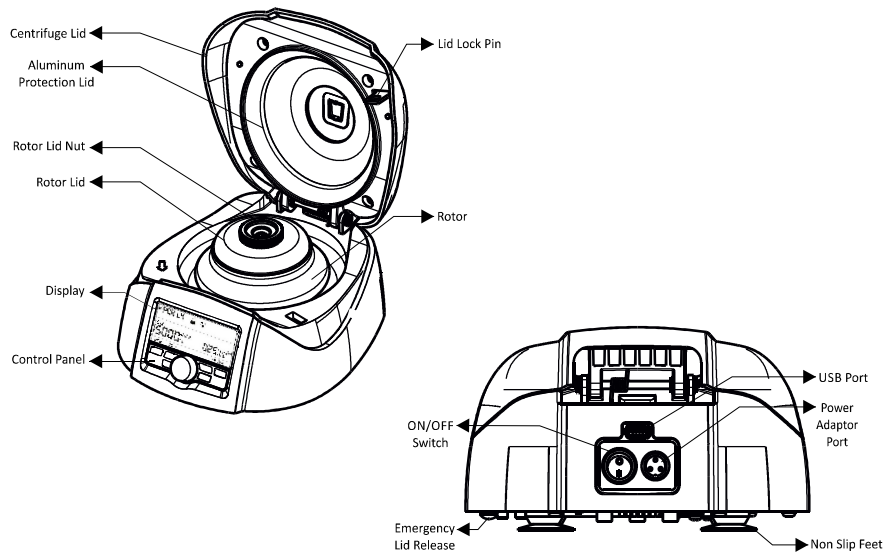

9. USER INTERFACE & DISPLAY

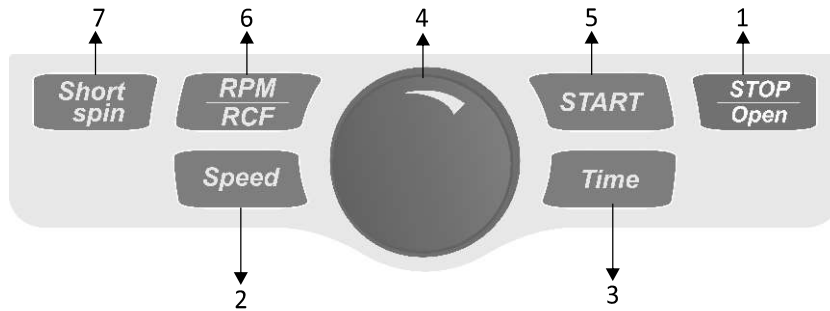

Item	Name	Function
1	STOP/OPEN BUTTON	Press button to STOP the ongoing operation. Lid opens automatically, after rotor comes to a stop.
2	SPEED BUTTON	Press button to select SPEED mode. Then rotate Item 4 to set desired run SPEED.
3	TIME BUTTON	Press button to select TIME mode. Then rotate Item 4 to set desired run TIME.

4	SETTING BUTTON	Use to set speed and time. Rotate the knob clockwise to increase and counter clockwise to decrease values.
5	START BUTTON	Press button to START running the centrifuge.
6	RPM/RCF BUTTON	Use to set/read RPM/RCF values.
7	SHORT SPIN BUTTON	Press and hold short spin button after setting the required speed to run the centrifuge for a short time.

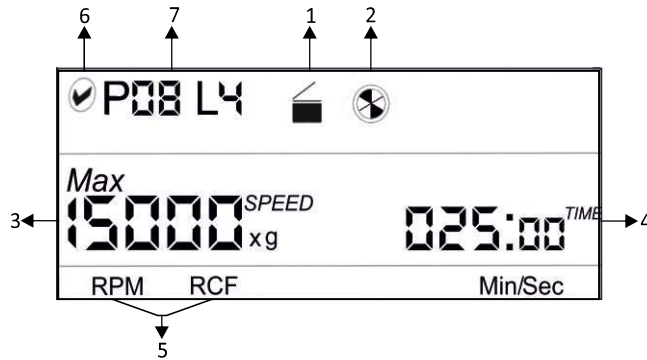







Item	Symbol	Description
1		Indicates lid status. Left image = lid close and Right image = lid open.
2		Indicates centrifuge status. When centrifuge is running the symbol rotates and when centrifuge is not running the symbol is static.
3		Indicates the speed value at which centrifuge is running. x g indicates the value in RCF mode.
4	RPM / RCF	Indicates RPM or RCF mode and shows corresponding values.
5		The timer is a countdown timer. It indicates the time for which the centrifuge will run. The time is displayed in Min/Sec mode.
6		Centrifuge is connected via software. When this mode is active, control panel buttons (except stop button) will be deactivated.
7	P08 L4	Indicates the specific program details being used. (Applicable in remote operation mode)

10. ROTOR INSTALLATION

• ROTORS AND ACCESSORIES

The table below shows rotors compatible with the centrifuge and the Max. RCF with different tubes and adaptors.

12 tubes rotor	1.5/2.0ml tubes	0.5ml Adaptor	0.1/0.2ml Adaptor		PCR strip rotor (Optional)	0.2ml PCR strip
						
			0.1ml	0.2ml		
Max. Speed	15000	15000	15000	15000	Max. Speed	15000
Max. RCF	15596.1	13017.7	10278.3	11105.9	Max. RCF	13080

NOTE: Always use recommended accessories for best results and product safety.

• ROTOR REMOVAL AND REPLACEMENT PROCESS

The rotor comes pre-installed with the centrifuge. If you want to remove or replace the rotor, follow the instructions below.

• REMOVING THE ROTOR

1. Do not remove or loosen the rotor lid before attempting to remove the rotor.
2. Using the T - Allen Key, loosen the rotor nut by turning it counter clockwise. Do not try to pull the rotor, the rotor will come up automatically.
3. Once the rotor nut is loosened completely, pull up the rotor vertically.

• REPLACING THE ROTOR

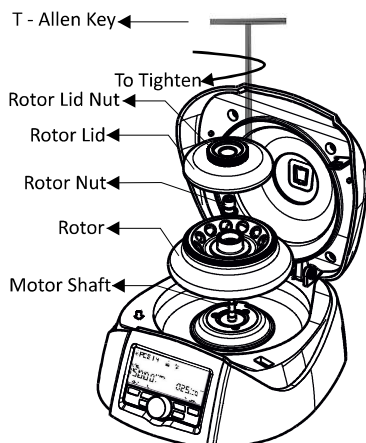

1. To replace or install the rotor, take the rotor and load vertically onto the motor shaft.
2. Place the rotor nut in the center hole of the rotor onto the motor shaft.
3. Put T -Allen Key into the rotor nut and turn clockwise to tighten and counter clockwise to loosen the rotor.
4. After properly fastening the rotor, place the rotor lid on the rotor lid nut by hand and rotate the rotor lid nut clockwise.

Note: 1) Check the rotor is firmly tightened before running the next program.

2) Do not remove or loosen the rotor lid before removing the rotor.

• BALANCING THE ROTOR

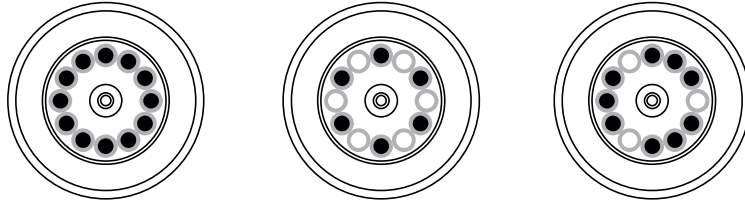

1. Always balance the rotor before centrifugation. Above are examples of properly balanced rotors.
2. The samples in the tubes should be of equal volume.
3. If the tubes are not loaded correctly - vibration or imbalance can occur which can cause serious damage to the centrifuge.
4. If the tubes are not loaded symmetrically then the imbalance detector will cut off the running centrifuge for device & user safety. This will stop the centrifuge and Err 55 will be seen indicating tubes are not loaded symmetrically. To resume operation, load tubes symmetrically & restart the centrifuge.
5. Incorrect method of loading tubes in centrifuge rotor :

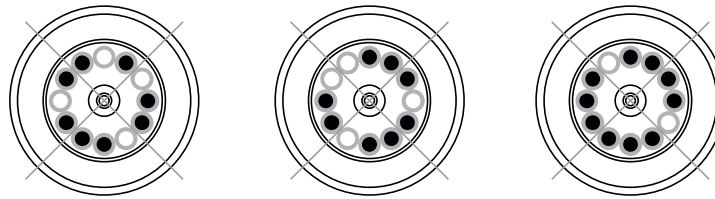

11. OPERATING THE CENTRIFUGE

• STARTING THE CENTRIFUGE

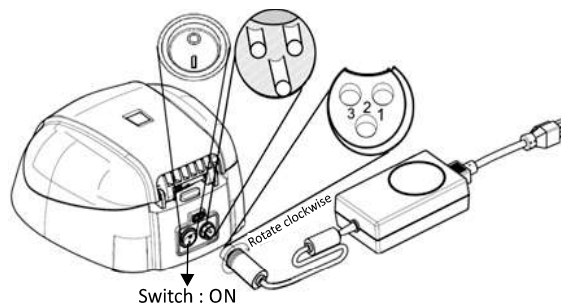

After connecting the power adaptor, switch ON the power at the rear side of the centrifuge. Make sure to check the rotor fit before use. Centrifuge will not operate with an open lid.

NOTE: Maintain a gap of 3 seconds between turning off and turning on the centrifuge. DO NOT turn off and turn on the centrifuge instantly.

• SETTING THE SPEED AND TIME

After closing the centrifuge lid; press the “SPEED BUTTON” to select the speed setting. Now rotate the “SETTING KNOB” clockwise to increase the speed value and rotate counter clockwise to decrease the speed value. The minimum and maximum speed of the centrifuge is 500 RPM and 15000 RPM respectively.

1. Pressing the speed button “ONCE” will make the speed change in interval of 1000s. For example: if the speed is 10000 RPM, then next speed will be 11000 RPM.
2. Pressing the speed button “TWICE” will make the speed change in interval of 100s. For example: if the speed is 10000 RPM, then next speed will be 10100 RPM.
3. Pressing the speed button more than 2 times will start the process from point 1 again.
4. The input will be accepted if the setting knob is left idle for 3 seconds. The value will blink five times to indicate acceptance.

The speed can be changed while the centrifuge is running. Press the speed button and follow the steps above. Once the speed is changed during centrifugation it will remain for the rest of centrifugation cycle. Speed and time can be changed multiple times during the centrifugation cycle.

Press the “TIME BUTTON” to select the time setting. Now rotate the “SETTING KNOB” clockwise to increase the time and rotate counter clockwise to decrease the time. The centrifuge timer is set to run between 30 seconds to 999 minutes or operate in infinite time mode. Infinite timer will be indicated by ∞ in display. The minimum time setting is 30 seconds. The timer in the centrifuge is a countdown timer and the time in the display will be in “Min/Sec” mode. The same will be shown on the display.

1. Pressing the time button “ONCE” will make the time change in interval of minutes. For example: if the time is 005:00 (5 Mins 0 Sec), then the next time will be 006:00 (6 Mins 0 Sec).
2. Pressing the time button “TWICE” will make the time change in interval of seconds. For example: if time is 005:00 (5 Mins 0 Sec), then next time will be 005:01 (5 Mins 1 Sec).
3. Pressing the time button more than 2 times will start the process from point 1.
4. The input will be accepted if the setting knob is left idle for 3 seconds. The value will blink five times to indicate acceptance.

Press the “START BUTTON” to start operation and press “STOP/OPEN BUTTON” to stop the ongoing operation. When the centrifuge is running the symbol “ ” will be rotating. Pressing the “STOP/OPEN BUTTON” will stop the operation. The centrifuge lid will automatically open once the rotor comes to a stop. If the program running time ends, the centrifuge will stop and the lid will automatically open. When the centrifuge is not running the symbol “ ” will be stable. To open the lid without running the

centrifuge, press the stop/open button.

- **SWITCHING TO RCF DISPLAY**

Press "RPM/RCF BUTTON" to change the mode from RPM to RCF (Relative centrifugal force). After pressing the button the display will show the speed in RCF. Maximum RCF speed of the centrifuge is 15596 x g. The system will automatically convert the values from RPM to RCF and vice versa.

- **SHORT SPIN CENTRIFUGATION**

Press "SHORT SPIN BUTTON": Short Spin Centrifugation is the feature for short/pulse run. It will run as long as the button is pressed. Set rotational speed prior to short spin as required. During the short spin the timer will be in incremental mode. After releasing short spin button the time in the display will show duration of short spin.

- **OPENING THE CENTRIFUGE LID IN POWER FAILURE**

Disconnect the centrifuge from the power supply. Wait until the rotor has come to a stillstand (this may take time). Once the rotor has stopped, pull down the emergency lid release cap present below the centrifuge. This will open the centrifuge lid.

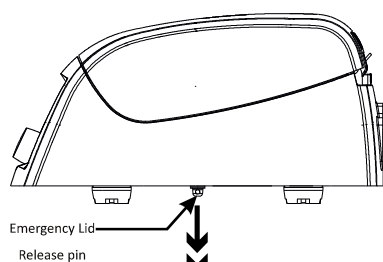

- **IMBALANCE DETECTION**

The centrifuge comes with an imbalance detection safety feature. When the rotor is not loaded symmetrically, the imbalance detector gets activated and stops any centrifugation. Error message "Err 55" will be shown on the display. Correct the imbalance load using the method described in the Balancing The Rotor section (page no. 13) of this manual. After correcting the imbalance, turn off the centrifuge & turn it back on. The values will be the same as set before the imbalance occurred. The imbalance detection feature cannot be deactivated, as it is a factory fitted safety feature.

12. REMOTE OPERATION & PROGRAMMING

For programming and remote operation the centrifuge needs to be connected to a computer.

- **SYSTEM REQUIREMENT**

The Graphical user interface (GUI hereafter) software and data log file require at least the following system to operate:

Operation System: Windows® 7 with i3 Processor or higher with 32 bit or 64 bit operating system and Windows® XP Sp3.

Microsoft .NET framework 4 and Microsoft Office Excel 2007 or 2010 is required for operating GUI.

- **INSTALLING GUI SOFTWARE**

GUI Software CD is provided with the centrifuge kit. Install the software from the CD by running the setup file. After the installation, the GUI software icon and centrifuge data log file will appear on the desktop.

- **CONNECTING USB CABLE**

Connect one side of the USB cable to back side of the centrifuge and another side to computer USB port. Without the USB connection the centrifuge will not operate through the software. USB connection is shown below.

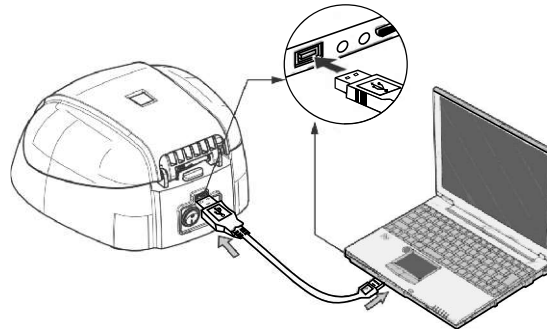

After the USB has been connected a symbol at the top left in the centrifuge display will appear to conform & indicate that the centrifuge is recognizing this connection

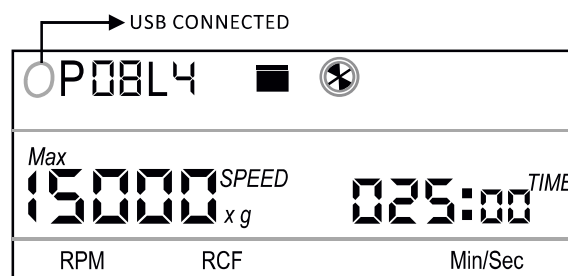

Once the USB cord is connected, the centrifuge unit controls will be disabled. The centrifuge can now be run using the program. Only the "STOP/OPEN BUTTON" will be functional on the control panel.

- **UNDERSTANDING THE GUI AND OPERATION**

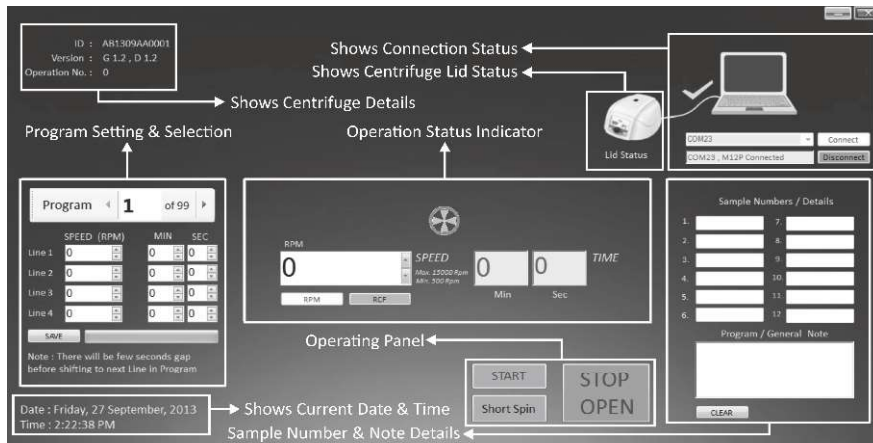

COM PORT CONNECTING AND DISCONNECTING



Once you connect the USB cable, the COM PORT for the centrifuge is detected automatically. Click on the CONNECT button to connect centrifuge and computer for remote operation. After connection, the TEXT BOX will show "COM, M12P Connected".

NOTE: If any other device is connected after connecting the centrifuge then the COM PORT of software gets updated. Select the centrifuge COM PORT from the COM PORT drop down box and click connect to reconnect the centrifuge.

NOTE: Once the software is connected, the buttons on the centrifuge are deactivated and only stop button will operate.

THE CENTRIFUGE DETAILS



After the centrifuge has been connected, the centrifuge ID and version will display in the GUI screen. The operation number shows the number of operations performed using the software.

SETTING A PROGRAM

Remote operation provides 99 programs and with 4 lines maximum per program. It can be used to pre-set and save programs for specific and or regular operations.

Below is an example of a program:

1. Run centrifuge for 2 minutes and 7 seconds with speed 15000 RPM
2. Then take a pause of 30 seconds
3. Then run centrifuge for 3 minutes and 22 seconds with speed of 7500 RPM
4. Then take a pause of 4 minutes and 15 seconds

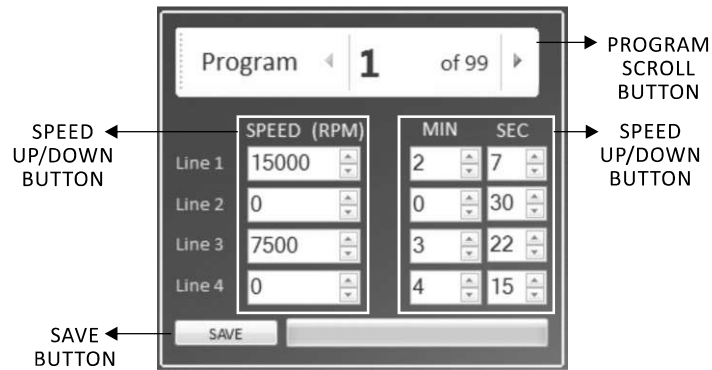

Note: There is delay of 8 seconds between all 4 lines.

After completing at least one program line, the centrifuge display will change as shown below.

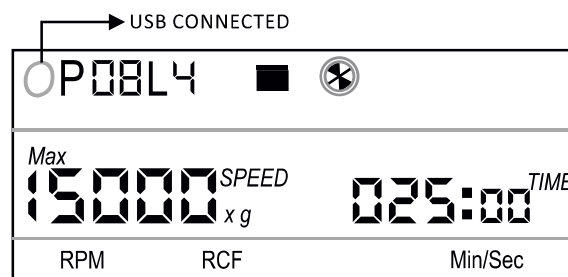

Click on the “PROGRAM SCROLL BUTTON” to select the required program out of the total 99 programs you wish to set. Start with the 1st line click on the “SPEED UP/DOWN BUTTON” to select value of the specific line, of the program. Speed can be set only in RPM mode. Click on “TIME UP/DOWN BUTTON” to select time value of specific line of the program. Up to 4 lines of a program can be saved. Operation will always start from the 1st line. After changing speed and time for centrifugation according to user requirement click on the “SAVE” button to save/set the program. Follow the same procedure for other lines of the program as needed.

PROGRAM NOTE AND SAMPLE NUMBERS

Users can write the details of each sample used for centrifugation for reference purposes. Users can also write General Notes regarding the sample used, operation details or any other specific information which is worth mentioning in “Program / General Note” text box as shown in the diagram below. The data entered here will be saved in the data log report.

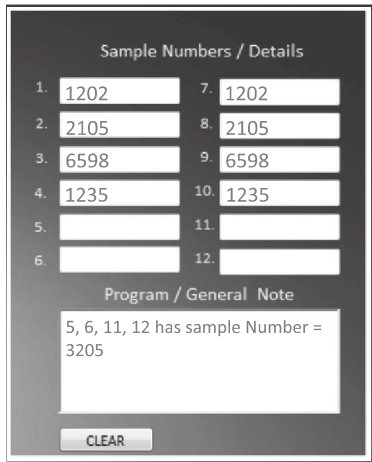

Click on the “CLEAR” button to clear the sample number and general note details of the program.

PRE-SET PROGRAM SELECTION AND OPERATION



Click on the “PROGRAM” scroll button to select the required pre-set program out of total 99 programs.



After selecting the required program, click on the “START” button to start the operation. Operation will start from 1st line of the selected program. There is a delay pause of 8 seconds between all 4 lines. Once the 1st line operation is over it will wait for 8 seconds to start the 2nd line

operation. During the operation all the buttons on the device and boxes of the GUI will be disabled except the “STOP/OPEN” button. When the centrifuge is running the symbol in the GUI ⚙ will rotate.

STOP OPERATION

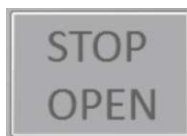

Click on “STOP/OPEN” button to stop the ongoing operation. The centrifuge lid opens automatically when the rotor comes to a stillstand. Users can also stop the ongoing operation by pressing “STOP/OPEN” button on the device. The lid status will be indicated on the GUI screen.

ACTIVE LINE SPEED DISPLAY



This “SPEED UP/DOWN” box is used to read the speed value of active lines of the program. For example: if line 3 of the 46th program is running then the “SPEED UP/DOWN” box will display the speed value of line 3 of the 46th program. It can

be used to change the speed value of the active line.

Click on “RPM” or “RCF” button to read speed value in RPM or RCF mode for active line.

ACTIVE LINE TIME DISPLAY



“TIME TEXT” box is used to read the remaining time value of active lines of the program. For example: if line 3 of the 46th program is running then the “TIME TEXT” box will display the remaining time value of line 3 of the 46th program. This is a countdown timer.

SHORT SPIN CENTRIFUGATION

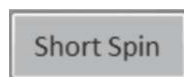

After setting required speed in the “SPEED UP/DOWN” box click the “SHORT SPIN” button for short spin operation. The timer display in this mode is created in seconds. During short spin operation the “TIME TEXT” box will disable as the timer converts to a count up timer. Press the “STOP/OPEN” button to stop the short spin operation.



The above images will be displayed in the screen according to the status of the lid.

8.3.12 CENTRIFUGE STATUS

This symbol shows the centrifuge status. When the centrifuge is running the symbol rotates and when centrifuge is not running the symbol is static.



NOTE: Centrifuge will get connected to a computer only if the USB cord is connected to both centrifuge and computer. Proper selection of centrifuge COM PORT is necessary to enable the remote operation.

NOTE: It is highly recommended not to use or work on any other application or do online work while GUI is operating.

• DATA LOG

The remote operation comes with data log features. All operations performed through the GUI will be saved as an excel sheet. With the help of the data log, users can view and make a print out of the previously performed operations.

Users can access the data log file from their desktop. Data log file named “Centrifuge_Data_Logger” will be generated automatically on the desktop of the user’s computer once the operation is performed.

The following type of operation details will be saved in an excel sheet.

	A	B	C	D	E	F	G	H
7	Date : Friday, 19 July, 2013							
8	Time : 4:45:25 PM							
9	Centrifuge ID : AA1307B30001							
10	Version No. : G 1.2 , D 1.2							
11	Operation No. : 1							
12	S1:							
13	S2:							
14	S3:							
15	S4:							
16	S5:							
17	S6:							
18	S7:							
19	S8:							
20	S9:							
21	S10:							
22	S11:							
23	S12:							
24	Note :							
25	NORMAL Operation							
26	P : 1							
27	L : 1							
28	SET SPEED : 15000 RPM							
29	SET TIME : 2 Min And 51 Sec							
30							
31	STOP TIME : 2 Min And 27 Sec							
32	Run TIME : 0 Hour And 0 Min And 24 Sec							
33	ERROR STATUS :							

NOTE: The GUI software will not operate if "Centrifuge_Data_Logger" file is open. Ensure to close the log sheet before remote operation.

13. MAINTENANCE AND CLEANING

1. The rotor and the outside of the centrifuge should be cleaned regularly with a moist cloth.
2. Ensure that while cleaning the unit it is not plugged in.
3. Wear protective gloves and safety glasses while operating and cleaning the device.
4. The brushless motor in the centrifuge does not require routine maintenance. Any required service should be performed by authorized, qualified personnel only. Repairs performed by unauthorized personnel may void the warranty.
5. Always keep the centrifuge housing, rotor chamber, rotor and rotor accessories clean. All parts should be wiped down periodically with a soft cloth. For more thorough cleaning, use a neutral cleaning agent (Ph between 6 and 8) applied with a soft cloth. Excessive amounts of liquid should be avoided. Liquid should not come into contact with the motor.

6. After cleaning, ensure that all parts are dried.
7. It is important to regularly clean the rotor.
8. If the rotor chamber needs cleaning, clean it with a cloth or a sponge moistened with a neutral detergent solution (like water).
9. Do not place the rotor into the cleaning solution!
10. If corrosive, toxic or pathogenic bacteria are accidentally spilled in the rotor or rotor chamber, the centrifuge must be decontaminated thoroughly.

Warning! *This product does not contain bio-seals as per IEC/EN/CSA 61010-2-20 and cannot provide any level of containment in case of a spill or release of toxic, radioactive, or pathogenic micro-organisms thus these materials are not recommended to be used in this product.*

14. TROUBLESHOOTING

This centrifuge has a self – diagnostic function. If a problem occurs, an error/warning code will be displayed on the display screen and the operator can determine the malfunction with the warning code below.

ERROR	PROBLEM	SOLUTION
No display	No main power connection.	Power check & proper plug-in of main cable at both ends.
	Power failure	Check the mains fuse of the lab.
	Improper connection.	Connect adaptor properly.
	Lid not closed correctly.	Close lid correctly.
	Error with lid closing and opening mechanism.	Contact service.
Err 55	Rotor not loaded symmetrically.	Load rotor symmetrically & restart centrifuge.
Centrifuge lid cannot be opened	Rotor is still spinning.	Wait for the rotor to come to a stop.
	Power failure	Press emergency lid release after rotor stops
Centrifuge shakes during acceleration & makes while running noise	Rotor is not loaded symmetrically.	Load rotor symmetrically & restart operation
	Either a broken tube, damage to the rotor or motor is the cause for run noise.	Replace broken tubes. For damaged rotor/motor contact a service representative.
	Rotor is damaged.	Remove & change rotor

Display error	Loose connection of display.	Contact service representative.
Err 2	Lid is not properly latched	Open lid and close it properly.
Err 52	Rotor is stuck	Turn OFF the centrifuge, Check the rotor for proper fit & turn ON centrifuge again.
Power tripping	Cable does not fit properly.	Remove cable and connect properly.
Last run memory not displayed	The centrifuge was turned ON immediately after being turned OFF.	Maintain a 3 second gap Between turning the centrifuge OFF and ON.
System gets hung up	Electronics error.	Switch off centrifuge and then switch it ON again. If the error still shows, contact service representative.

IMPORTANT NOTE:

1. *Maintain a 3 second gap between restarting the centrifuge. Instant ON-OFF can lead to a reset, erasing last run memory.*
2. *If the motor gets hot due to which there will be a fluctuation in speed value then allow the centrifuge to cool for at least 30 minutes. Do not do any operation for 30 minutes*
3. *Do not use liquids with density higher than 1.2g/ml for full load operation.*

15. WARRANTY STATEMENT

This product is warranted to be free from defects in material and workmanship for a period of two (2) years from date of purchase. Your product will be duly repaired upon prompt notification in compliance with the following conditions :

- This warranty is valid only if the product is used for its intended purpose and within the guidelines specified in this instruction manual. This warranty does not cover damage caused by accidents, neglect, misuse, improper service, natural forces or other causes not arising from defects in original material or workmanship. This warranty does not cover any incidental or consequential damages, commercial loss or any other damages from the use of this product.

- The warranty is invalidated by any non-factory modification, which will immediately terminate all liabilities on us for the products or damages caused by its use. The customer shall be responsible for the product or use of products as well as any supervision required for safety. If requested the products must be returned to the distributor in well packed and insured manner and all shipping charges must be paid.

Note: *Some states do not allow limitation on the length of implied warranties or the*

exclusion or limitation of incidental or consequential damages. This warranty gives you specific legal rights. This warranty is given expressly in lieu of all other warranties, expressed or implied.

- The purchaser agrees that there is no warranty of merchantability or of fitness for any intended purpose and there are no other remedies or warranties, implied, which extend beyond the description on the face of the agreement. This warranty is only applicable to the original purchaser.
- Products received without proper authorization will not be processed for warranty or service. All items returned for service should be sent with postage prepaid in the original packaging or other suitable packaging, padded to avoid damage. We will not be responsible for damage incurred by improper packaging.

Note: *This warranty is valid only if the warranty is registered with the supplier within 30 days from the date of purchase.*

16. PRODUCT DISPOSAL

In case the product is to be disposed of, the relevant legal regulations are to be observed.

Information on the disposal of electrical and electronic devices in the European Community

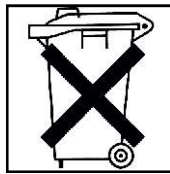

The disposal of electrical devices is regulated within the European Community by national regulations based on EU Directive 2012/19/EU on waste electrical and electronic equipment (WEEE). According to these regulations, any devices supplied after 13.06.05 in the business to business sphere, to which this product is assigned, may no longer be disposed off in municipal or domestic waste. They are marked with the following symbol to indicate this.

As disposal regulations within the EU may vary from country to country, please contact your supplier if necessary.

For your reference, make a note of the serial number, date of purchase and supplier here.	
Serial No.	Purchase Date
Supplier	



AHN Biotechnologie GmbH
Uthleber Weg 14, 99734, Nordhausen, Germany
Telefon +49(0)3631 65242-0 • Fax +49(0)3631 65242-90
www.capp.dk / info@capp.dk

0111-01-0000-02-003-R2