

ergoselect 100/150/200

Bicycle Ergometer

Operator's Manual

201000134000 • Version 2024-09-02/Rev 08 • English



This manual was written with the utmost care. Should you still find details that do not correspond with the system, please let us know and we will correct the issue as soon as possible.

We reserve the right to modify the design and technical features of the device and are not bound by the information and illustrations provided in this manual.

All trademarks appearing in this document are trademarks of their respective owners. Their protection is acknowledged.

No part of this manual may be reprinted, translated or reproduced without the manufacturer's written permission.

This manual is not subject to any change order service. Please contact the manufacturer for the latest document revision.

The document „Cleaning, and Disinfecting ergoline Medical Devices“ (Part No. 201000641000) in its most recent version is also part of this manual. This document is exclusively made available for download from the ergoline website www.ergoline.com.

ergoline GmbH
Lindenstraße 5
72475 Bitz
Germany

Tel.: +49-(0) 7431 98 94 - 0
Fax: +49-(0) 7431 98 94 - 128
e-mail: info@ergoline.com
http: www.ergoline.com

Printed in Germany



CONTENTS

General Information	5
Symbols	6
Intended Use	8
Intended Purpose	8
Clinical Benefit	8
Indications, Contra-indications and Exclusions, Criteria for Termination	8
Intended User	9
Intended Patient Group	9
Biocompatibility	9
Safety Information	10
Setup and Mains Connection	12
Controls and Indicators	12
Transport	13
Setup	13
Mounting the Control Terminal (P or K)	14
Connecting the Power Cord	14
Connecting the ECG Cable	16
Connecting the Blood Pressure Cuff	17
Connecting the SpO ₂ Sensor	17
Preparing the Patient	18
Adjusting saddle and handlebar	18
Adjusting the handlebar angle	18
Blood Pressure Module	19
Safety Information for Non-Invasive Blood Pressure Measurement	19
Checking the Cuff Tubing	21
SMARTsat® SpO₂ Module	22
Operation	25
Control Terminal P	25
Turning the System On	25
Operating Modes with Control Terminal P	26
PC Mode	27
Ergometry	28
Manual	30
Settings with Control Terminal P	31
Control Terminal K	36
Turning the System On	36
Operating Modes with Control Terminal K	37
Speed readout	37
PC Mode	38
Ergometry	39
Manual	41
Training	42
Training with Chip Card	43
Settings for Control Terminals K	45

Cleaning, Disinfection and General Hygiene Measures	52
General Product Information	53
Accessories/Compatible Devices	54
Technical Specifications	55
Electromagnetic Compatibility EN 60601-1-2.	60

GENERAL INFORMATION



DANGER

indicates an imminent hazard. If not avoided, the hazard will result in death or serious injury.



WARNING

indicates a hazard. If not avoided, the hazard may result in minor injury and/or product/property damage.



CAUTION

indicates a potential hazard. If not avoided, the hazard may result in minor injury and/or product/property damage.

- If unauthorized individuals open the control terminal, damaging the calibration sticker, any warranty claim shall become void.
- This manual reflects the device specifications and applicable safety standards valid at the time of printing. All rights are reserved for devices, circuits, techniques, software programs, and names appearing in this manual.
- On request ergoline will provide a Field Service Manual.
- The implemented quality management system covers all aspects of the ergoline operations as per EN ISO 13485.
- To ensure patient safety, the specified measuring accuracy, and interference-free operation, we recommend using only original ergoline accessories. The user is responsible if accessories from other manufacturers are used.
- ergoline is responsible for the safety, reliability, and performance of the device, only if
 - modifications and repair are carried out by ergoline GmbH or by an organization expressly authorized by ergoline GmbH
 - the device is used in accordance with the instructions given in this operator's manual.
- The product ergoselect bears the CE marking CE-0123 (Notified Body: TÜV), indicating its compliance with the provisions of the Council Directive 93/42/EEC about medical devices and fulfills the essential requirements of Annex I of this directive. The CE marking covers only the accessories listed in the Order Information chapter. The device is an MDD class IIa product.
- The device fulfills the requirements of the standard EN 60601-1 "Medical electrical equipment, Part 1: General Requirements for Safety" as well as the interference protection requirements of standard EN 60601-1-2 "Electromagnetic Compatibility – Medical Electrical Devices". The radio-interference emitted by this product is within the limits specified in EN 55011, class B.
- This manual is an integral part of the device. It should be kept near the device at all times. Close observance of the information given in the manual is a prerequisite for proper device performance and correct operation and ensures patient and user safety. Please note that information pertinent to several chapters is given only once. Therefore, read the manual once carefully in its entirety.
- Observance of the safety information protects from injuries and prevents inappropriate use of the device. All device users and persons responsible for assembly, maintenance, inspection, and repair of the device must read and understand the content of this manual, before using the device or working with it. Paragraphs with special symbols are of particular importance.

SYMBOLS

	Symbol 'type B applied part'. Type B applied parts have no direct contact with patients and offer the lowest protection against electric shock.		Manufacturer.
	Symbol 'type BF applied part' Type BF applied parts are connected to the body of the patient and provide a higher degree of protection against electric shock. The applied parts are isolated.		Date of manufacture The number found under this symbol is the date of manufacture in the YYYY-MM-DD format.
	Observe the information given in the operator's manual.		PVC-free.
	Protection class II equipment.		Latex-free.
	This symbol indicates that the waste of electrical and electronic equipment must not be disposed of as unsorted municipal waste and must be collected separately.		Suitable for the indicated arm circumference.
	Order number / catalog number.		Small size.
	Serial number.		Standard size.
	Scheduled date of the next inspection (e.g., March 2024).		Large size.
	Toggle switch ON (voltage).		Medical device
	Toggle switch OFF (voltage).		Authorized representative for Switzerland.
	CE mark per the Medical Device Directive 93/42/EEC of the European Union. Notified body: TÜV SÜD Product Service GmbH, Ridlerstr. 65, 80339 München, Germany.		Transport and storage label: this way up.
	Own weight of ergometer.		Transport and storage label: keep dry.
	Nationally Recognized Testing Laboratory NRTL label for the USA and Canada.		Transport and storage label: fragile, handle with care.
	Do not lean against device: tipping hazard.		Transport and storage label: temperature limits.
			Transport and storage label: humidity limits.
			Transport and storage label: atmospheric pressure limits.



Transport and storage label:
do not stack.



Consult operator's manual.



Prescription only. Caution: U.S. Federal Law restricts
this device to sale by or on the order of a physician.



Not made with natural rubber latex.



Not made with DEHP.



Do not throw away.



Do not use if package is open or damaged.



MR unsafe.



Keep away from sunlight.



Batch code/Lot number.

INTENDED USE

INTENDED PURPOSE

The medical device is an ergometer used to apply stress to a patient's cardiovascular and musculoskeletal systems and for exercise training.

CLINICAL BENEFIT

In cardiac rehabilitation and secondary prevention programs with the medical device, patients benefit from training by improving their physical capacity and, at the same time, by reducing the probability of recurrence of medical conditions such as cardiovascular diseases, metabolic disorders, cancers, pulmonary diseases or diseases resulting from a sedentary lifestyle. Furthermore, the medical device can be used as a diagnostic device in stress ergometry and exercise testing.

INDICATIONS, CONTRA-INDICATIONS AND EXCLUSIONS, CRITERIA FOR TERMINATION

INDICATIONS

- Asymptomatic subjects
 - diagnosis of latent disease and of possible risks in sport
 - assessment of physical performance ability and counseling before the start of training, monitoring and guidance of training
 - assessment of performance capacity and physical performance ability in occupational medicine
- Patients with ...
 - diagnosis of cardiovascular and pulmonary disease
 - evaluation of symptoms: dyspnea, chest pain, palpitations, dizziness (syncope)
- Follow-up assessment during training (for patients as well):
 - recommendations on the extent and intensity of training
 - in accordance with the above, the diagnostic objectives are the assessment of performance, development, suitability, and structure; stress is caused by external parameters and effort by "internal" ones as a response of the subject's organs to the task.

CONTRA-INDICATIONS AND EXCLUSIONS

- Absolute
 - any acute or severe chronic cardiorespiratory disease causing marked functional impairment (e.g., severe congestive heart failure, severe burns, cardiomyopathy, severe arrhythmias, thromboses, malignant hypertension, or pulmonary hypertension)

- any acute or severe disease of other organ systems, e.g., nephritis, poorly controlled diabetes mellitus, or electrolyte disturbances
- febrile infections
- musculoskeletal and neuromuscular disorders that preclude safe and adequate test performance

- Relative
 - known obstructive left main coronary artery stenosis
 - moderate to severe aortic stenosis with uncertain relation to symptoms
 - tachyarrhythmia or bradyarrhythmia with uncontrolled ventricular rate
 - moderate to severe valvular heart disease
 - acquired advanced or complete heart block
 - hypertrophic obstructive cardiomyopathy with severe resting gradient
 - recent stroke or transient ischemic attack
 - age or mental impairment leading to inability to cooperate
 - resting hypertension with systolic or diastolic blood pressures > 200/110 mmHg
 - uncorrected medical conditions, such as significant anemia, important electrolyte imbalance, and hyperthyroidism
 - ventricular aneurysm

CRITERIA FOR TERMINATION

- Subjective symptoms
 - dizziness
 - incoordination
 - progressive chest pain
 - shortness of breath
 - pain in the legs or disability to perform the test
- Objective signs
 - ECG changes
 - progressively severe arrhythmias
 - progressive intracardiac conduction disturbance
 - progressive repolarization disorder
 - hemodynamic changes
 - progressive drop in blood pressure
 - insufficient rise in blood pressure
 - excessive rise in blood pressure
 - abnormal findings during auscultation of the lungs (e.g., breath sounds such as cawing, wheezing)

COMPLICATIONS ASSOCIATED WITH STRESS TESTS

- Cardiological complications
 - Bradyarrhythmias
 - Tachyarrhythmias
 - Acute coronary syndrome
 - Heart failure
 - Hypotension, syncope and shock
 - Death (rare; estimated frequency: 1 per 10,000 tests, but probably less)
- Non-cardiological complications
 - Musculoskeletal trauma
 - Soft tissue injuries
- Miscellaneous
 - Severe fatigue (feeling unwell), sometimes lasting for days
 - Dizziness
 - Physical pain
 - Delayed onset of non-specific, mild symptoms of illness

INTENDED USER

Only the intended users are allowed to use the ergometer.

Intended users are, among others, healthcare professionals thoroughly instructed on the basis of the operator's manual, such as

- physicians
- healthcare providers
- therapists

INTENDED PATIENT GROUP

The intended patient group includes all persons

- with a body height of 120 – 210 cm.
- with a maximum weight of 160 kg.
- whose medical condition has been checked by a medical specialist who judged them to be suitable for the application described in the intended use.

BIOCOMPATIBILITY

The parts of the product described in this manual, including all accessories that come in contact with the patient during the intended use, fulfill the biocompatibility requirements of the applicable standards if applied as intended.

If you have questions in this matter, please contact ergoline GmbH or an ergoline representative.

SAFETY INFORMATION



DANGER

- **Explosion Hazard** •

The device is not designed for use in areas where an explosion hazard may occur.

Explosion hazards may result from the use of flammable anesthetics, skin cleansing agents, or disinfectants.



WARNING

- **Patient Hazard, Equipment Damage** •

Do not expose the ergoselect to direct sunlight to prevent system components from reaching inadmissible high temperatures.

Do NOT use the ergoselect outdoors (medical device). Furthermore, the device has no additional protection against the ingress of humidity. Humidity inside the device may cause equipment malfunctions and increases the risk of an electric shock.

Additionally, the device should not be operated in the vicinity of power systems, because they may impair equipment functions.

The ergoselect may only be used in combination with accessories approved by ergoline GmbH.

- **Risk to Persons** •

Before using the ergometer, the user must ascertain that it is in correct working order and operating condition. The cables and connectors, in particular, must be checked for signs of damage. Damaged parts must be replaced immediately.

- **Equipment Malfunction** •

Only the special shielded cables supplied by ergoline may be used to connect the device to other pieces of equipment.

- **Equipment Malfunction** •

Cellular telephones may not be used in the immediate vicinity of the ergometer, because they might interfere with the proper functioning of the ergometer. Electromagnetic interference most probably exists when the watt reading is unstable. If the displayed value changes frequently even though the rotational speed is above 30 RPM, this may be due to electromagnetic interference.



WARNING

- **Shock Hazard** •

When the device is connected to other equipment or if a medical system is created, it must be ensured that the added leakage currents do not present a hazard. In case of questions, please contact your ergoline dealer or the ergoline GmbH Service Department.

For use, the ergometer must always be connected to electrical installations that fulfill the local requirements.

- **Patient Hazard** •

The German Medical Device Operator Ordinance (MPBetreibV, § 4) demands that users

- *must be trained in the use of the ergometer*
- *must be familiar with the routines for handling and assembly of the device*
- *must be familiar with and observe the safety rules and regulations for operation of this type of equipment*
- *must be informed about any other pertinent rules and regulations (e.g., safety instructions)*
- *must be informed about the potential hazards arising from the use of this type of equipment*
- *make sure that no unauthorized changes are carried out.*

- **Patient Hazard** •

The medical device is only intended for use by trained and appropriately qualified staff.



CAUTION

Additional equipment connected to medical electrical equipment must comply with the respective IEC or ISO standards (e.g., IEC 60950 for data processing equipment).

Furthermore, all configurations must meet the requirements of the applicable medical systems standards (see 3rd edition of IEC 60601-1).

Anybody connecting additional equipment to medical electrical equipment configures a medical system and is therefore responsible for the system's compliance with the requirements for medical electrical systems. Please note that local laws take precedence over the standards mentioned above.

In case of questions, please contact your local dealer or ergoline GmbH.



WARNING

- *The SpO₂ module should only be used for the purpose and in the manner described in this manual.*
- *The device must only be used by suitably qualified or trained personnel or under the supervision of trained personnel.*
- *To avoid incorrect measurements, injury to patients or damage to the device, operate the device under the specified environmental conditions only.*
- *For the SpO₂ measurement, the monitor uses red and infrared light with specific fixed wavelengths. Consider that these wavelengths might influence diagnostic parameters of other optical applications. The specifications of the wavelengths used are listed in the 'Instructions for Use' of the specific sensor.*
- *Certain environmental and physiological conditions, medical procedures, sensor application errors and external agents may interfere with the ability of SMARTsat® to detect and display accurate measurements.*
- *Only operate the device at the specified environmental conditions to prevent wrong measurement results, patient injury or damage to the device.*
- *Do not apply excessive tension to any of the monitor cables.*
- *Any radio frequency transmitting equipment or other nearby sources of electrical noise may result in disruption of the monitoring system.*
- *To prevent damage, avoid undue bending of the sensor cable.*
- *Use of this equipment adjacent to or stacked with other equipment should be avoided because it could result in improper operation. If such use is necessary, this equipment and the other equipment should be observed to verify that they are operating normally.*
- *Portable radio frequency communications equipment (including peripherals such as antenna cables and external antennas) should be used no closer than 30 cm (12 inches) to any part of the host monitor, including cables specified by the manufacturer. Otherwise, degradation of the performance of this equipment could result.*
- *The use of accessories, sensors, and cables other than those specified or provided by bluepoint Medical could result in increased electromagnetic emission or decreased electromagnetic immunity of this equipment and result in improper operation.*
- *Only use the compatible SpO₂ sensors listed in this document to prevent patient injury.*
- *Do not use sensors, cables or lines that appear to be damaged by transport or other means. Do not use sensors when optical components are exposed. Do not use a sensor or cable that appears damaged. Replace it immediately in cases of visible damage.*
- *If you are uncertain about the accuracy of any measurement, check the patient's vital signs by alternative means, then ensure that the device is functioning correctly.*
- *A functional tester (like Index II or equivalent) may not be used to validate SpO₂ accuracy. A functional tester can be used to verify the function of pulse oximeter probes.*

NOTICE

Only the removal of the power cord will result in an all-pole disconnection of the device from the power line.

SETUP AND MAINS CONNECTION

CONTROLS AND INDICATORS

- 1 Control terminal (model P or model K)
- 2 Blood pressure cuff connection (option)
- 3 Adjustment of the handlebar angle
- 4 Blood pressure cuff
- 5 Adjustment of the handlebar height (ergoselect 150/200 only)
- 6 Castors
- 7 Speed display (RPM) for patient
- 8 Adjustment of the saddle height (ergoselect 100/150 only)
- 9 Digital saddle height indication (ergoselect 200 only)
- 10 Power switch (green button)
- 11 Sockets for power cord and connection cables (underside of ergometer)
- 12 Levelling devices to adjust the ergometer to uneven floors

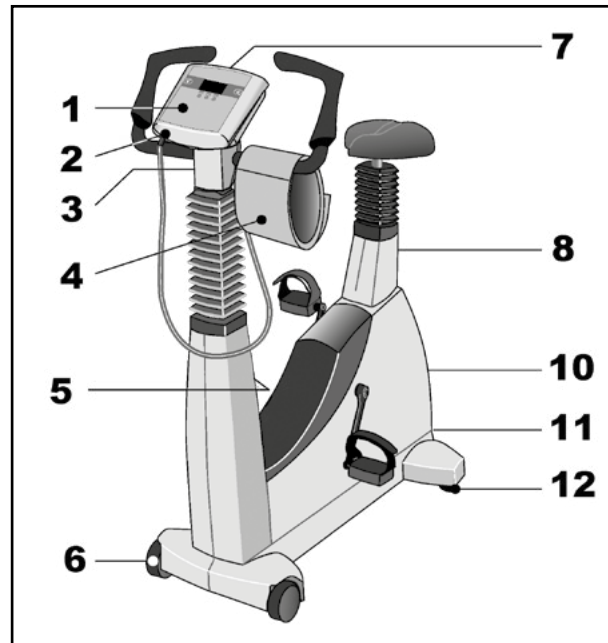

ERGOSELECT 100/150 – CONTROLS, CONNECTIONS AND INDICATORS

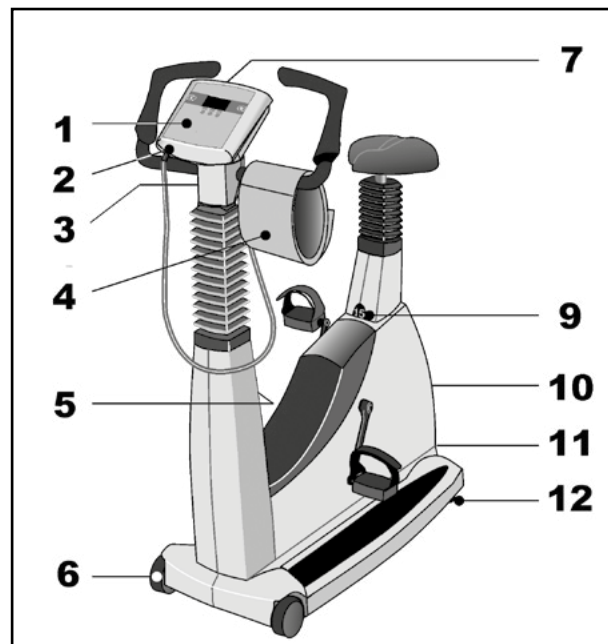

ERGOSELECT 200 – CONTROLS, CONNECTIONS AND INDICATORS

TRANSPORT

For short distances, the ergoselect can be lifted at the saddle and rolled away on its castors.

To cover greater distances, however, we recommend the following method:

- Disconnect the power cord from the wall outlet.
- Rotate the handlebar towards the front. Tighten the clamping lever.
- Stand in front of the ergoselect, grasp the handlebar and tilt the ergoselect towards you until it is standing on the castors only and is balanced.
- It is now possible to transport the ergoselect.
- When you have reached the new location, lower the ergoselect very carefully to avoid damage.

CAUTION

- **Equipment Damage** •
Avoid strong vibrations of the ergoselect during transport.



TRANSPORTING THE ERGOSELECT

SETUP

Place the ergoselect on a horizontal level floor.

The ergoselect must be set up in a secure and stable position - the two levelling feet at the back make for easy adjustment to uneven floor surfaces. Extend the foot concerned until the ergoselect no longer wobbles.

In case of delicate flooring, it is recommended to place a mat under the ergometer to protect the flooring from damage by the feet.

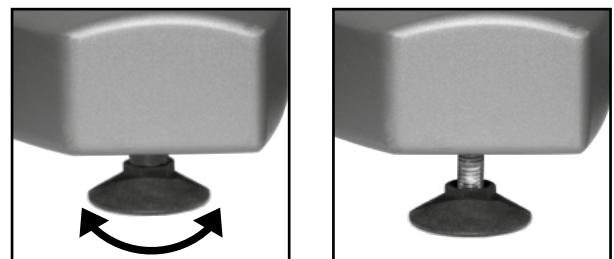

LEVELLING FEET OF THE ERGOSELECT ERGOMETER

MOUNTING THE CONTROL TERMINAL (P OR K)

The control terminal can be installed with the display either facing the patient or the operator.

It is recommended to install the terminal with the display and control keys towards the operator and the speed display towards the patient.

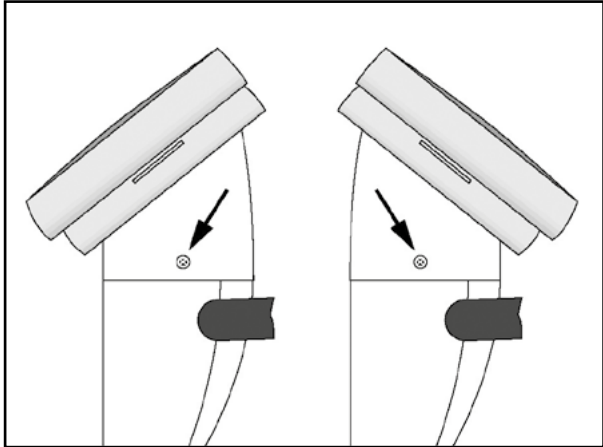

DIFFERENT ORIENTATIONS OF THE CONTROL TERMINAL

CONNECTING THE POWER CORD

Set the handlebar to the front upper position and secure. Tilt the ergoselect carefully towards you until it rests on the handlebar.



ASSEMBLY POSITION OF THE ERGOSELECT ERGOMETER

CAUTION

- **Equipment Damage** •

Before connecting the ergometer to the power line, check that the line voltage corresponds to the ratings on the type plate.

The type plate is located on the back of the ergometer, at the bottom.

The connection panel is located on the underside of the ergometer.

- Plug the power cord into socket (a) and use the supplied lock (b) to secure it against disconnection.
- Using the supplied strain relief, attach the cable to the metal frame.

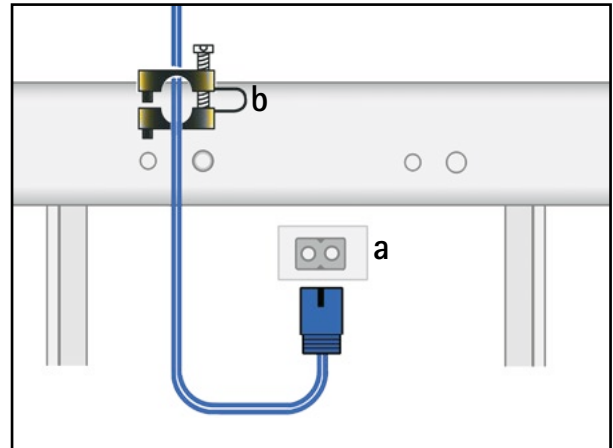

CONNECTION PANEL

a Power input

b Lock

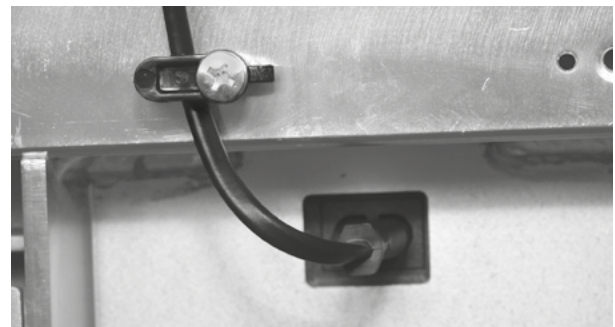

POWER CORD WITH INSTALLED STRAIN RELIEF

NOTICE

• **Disconnection from Power Supply** •

Pressing the power switch or removing the power cord disconnects the device from the power supply.

Removing the power cord results in a complete disconnection from the power supply (all poles).

Ensure that the power plug is readily accessible at all times.

CONNECTING THE ECG CABLE

ergoselect ergometers can be connected to electrocardiographs and PC-based ECG systems of most manufacturers.

Different connection cables are available to support different communication modes (digital, analog, remote start, etc.).

All ergoline ergometers are equipped with a digital interface (special adapters, which can be obtained from ergoline, are required for control of the ergometer with analog signals or for the remote start function).

The appropriate cable is plugged into the 9-pole port of the connection panel (Port 1) or into the USB port and secured at the metal frame with an additional strain relief.



EKG / PC CONNECTION

<i>USB</i>	<i>PC connection via USB (virtual COM)</i>
<i>PORT 1</i>	<i>Digital connection (remote control from PC or ECG recorder), connection for cable adapter (analog interface + remote start)</i>

NOTICE

• Connecting Cables •

Only use connecting cables released by ergoline.

To use the integrated USB connector, a special driver is required - contact ergoline.

CONNECTING THE BLOOD PRESSURE CUFF

- Connect the microphone at (1).
- Slip the cuff tubing onto the fitting (2) and engage. To disconnect, push back the connector's knurled sleeve.

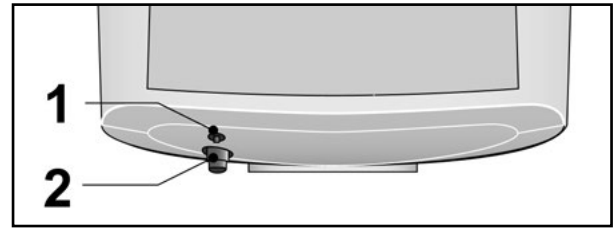

BLOOD PRESSURE CUFF CONNECTIONS

- 1 Microphone connection
- 2 Cuff tubing

Artifacts that may be caused by patient movements during the exercise test, must be avoided if possible, while the blood pressure is being taken.

Therefore, do not forget to attach the cuff tubing to the handlebar with the supplied Velcro tape:

- Open the large Velcro tape and wrap around handlebar.
- Secure the cuff tubing with the small Velcro tape, but do not exert pressure on the tubing.

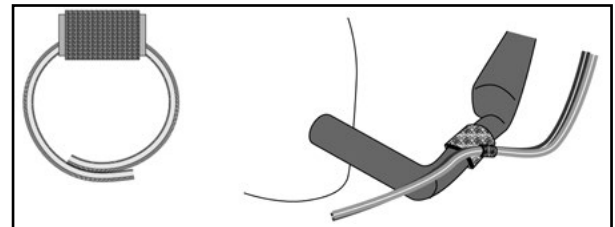

VELCRO TAPE TO SECURE THE CUFF TUBING

CONNECTING THE SpO₂ SENSOR

Before application and use, check the SpO₂ sensor and its package for damage. Do not use the sensor if you detect any signs of damage.

Connect the sensor cable to the corresponding socket (1) on the underside of the control terminal.

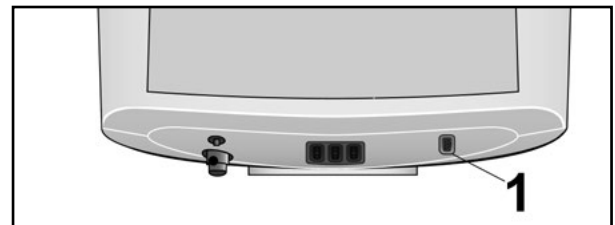

SpO₂ SENSOR CONNECTION

- 1 SpO₂ connection

NOTICE

Please observe the accompanying documents for the SpO₂ sensor.

PREPARING THE PATIENT

ADJUSTING SADDLE AND HANDLEBAR

On the ergoselect 100/150, the height of the saddle is adjusted manually with a clamping lever. On the ergoselect 200, the saddle height is adjusted electrically using the buttons provided on the control terminal (the current saddle height is indicated on a display below the saddle). When the pedal is in its lower position, there should be a 10° angle between the axis formed by the upper body and the thigh.

ADJUSTING THE HANDLEBAR ANGLE

To adjust the handlebar angle, loosen the clamping lever 1 by turning it counterclockwise. Choose a handlebar angle that allows the patient to sit straight and comfortably. Tighten clamping lever 1 again until hand tight by turning it clockwise. Then tighten the clamping lever another 1/4 turn clockwise so that the clamping is secure.

On the ergoselect 150/200, the height of the handlebar can also be adjusted with clamping lever 2 – the horizontal bar should be adjusted to roughly the same height as the saddle.

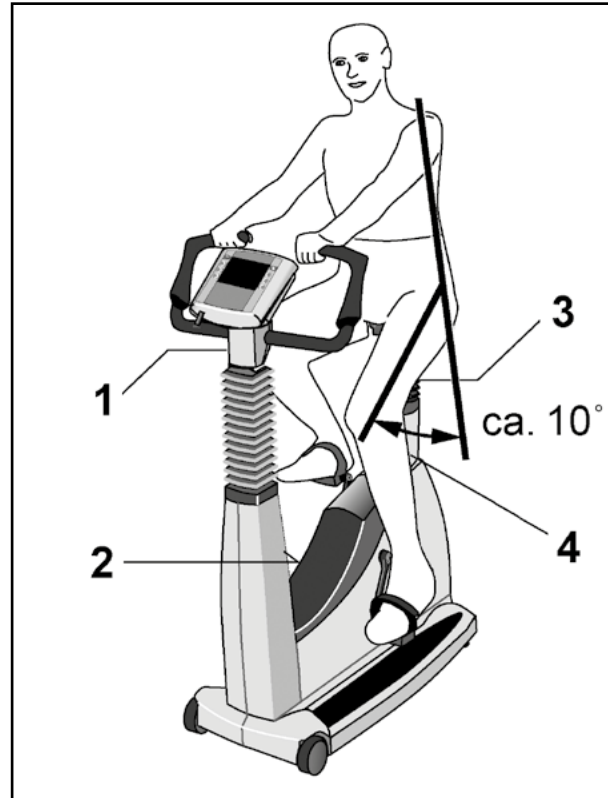

ADJUSTING SADDLE AND HANDLEBAR

- 1 Adjusting the handlebar angle
- 2 Adjusting the height of the handlebar (ergoselect 150/200 only)
- 3 Adjusting the height of the saddle (ergoselect 100/150 only)
- 4 Saddle height display (ergoselect 200 only)

Before allowing the patient to lean on the handlebar, check the clamp as follows:

DANGER

- With the ergometer standing firmly, check that the handlebar is tight by trying to push the handlebar downwards from above. Adjust the clamping force of the clamping lever if necessary.

*The handlebar is not designed to support the full body weight!
Risk of falling!*

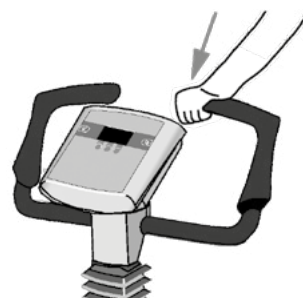

NOTICE

- Tighten the clamping levers only as tight as necessary, NOT with maximum force.
- Grease the threads of the clamping levers every 3 months at minimum, using a suitable grease, such as OKS470.

BLOOD PRESSURE MODULE

SAFETY INFORMATION FOR NON-INVASIVE BLOOD PRESSURE MEASUREMENT



WARNING

- Patient Hazard •

Do not take blood pressure measurements with a cuff on patients suffering from sickle cell anemia or where skin lesions are likely to occur.

The cuff may cause hematomas in patients with severe blood coagulation disease. In these instances, the user must take a decision for or against automatic blood pressure measurements.



CAUTION

- Compromised Measuring Accuracy •

Arrhythmias occurring frequently during a measurement may compromise the accuracy of the measurement. In certain cases, a valid measurement will not be possible.

Electromagnetic fields are also capable of impairing the measuring accuracy.

NOTICE

- *If the cuff pressure exceeds the maximum value of 300 mmHg during inflation, the inflation procedure will be aborted and the cuff deflated. As a redundant safety precaution, the cuff is immediately deflated when the cuff pressure exceeds 320 mmHg. You can check the proper functioning of this safety precaution by abruptly bending your arm while the cuff is being inflated, causing a brief overpressure in the cuff. The cuff must deflate immediately.*
- *Measurements that did not yield a valid measurement will not be repeated during the exercise test.*
- *If the inflation phase takes longer than 40 seconds or if an adequate pressure does not build up in the cuff within a reasonable period of time, the measurement will be aborted and the cuff deflated.*
- *If a valid measurement cannot be completed within 120 seconds, the measurement will be aborted and the cuff deflated.*
- *If the cuff pressure remains constant for some time, the measurement will also be aborted and the cuff deflated.*

CUFF SIZE

Always choose the cuff size suitable for the patient's arm. The maximum arm circumference is indicated on the cuff.

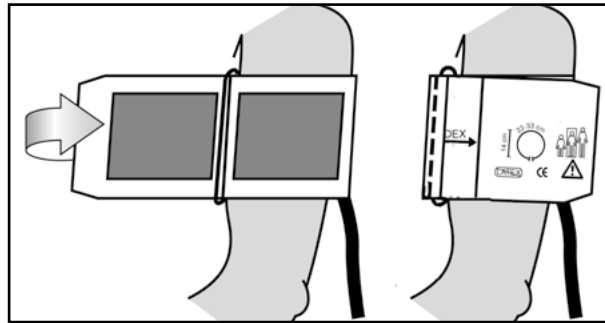

CORRECT CUFF SIZE

When you close the Velcro strap, check that the metal clasp (a) is inside the marked index range (b), and not outside.

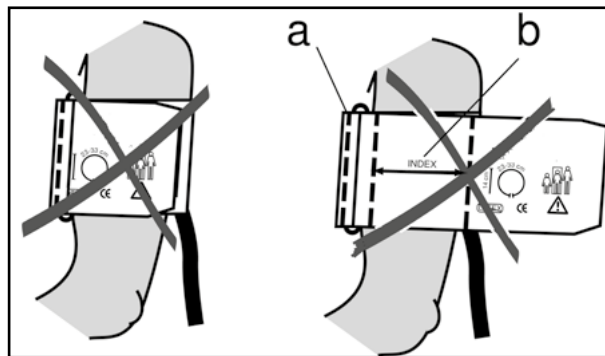

WRONG CUFF SIZE

MICROPHONE POSITION

Before applying the cuff, check the position of the microphone inside the red pocket (on the inside of the cuff): When the microphone is inside the pocket, its **metal side must face the arm**.

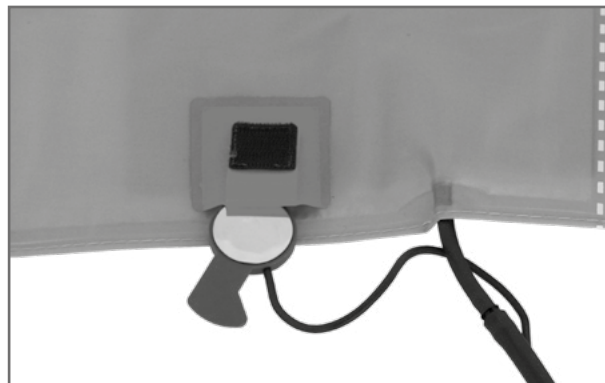

CORRECT MICROPHONE POSITION

APPLYING THE CUFF

The center of the microphone must be located exactly on the **brachial artery**. Locate the artery by palpation, if required. The **red tab** identifies the position of the microphone.

The accurate placement of the microphone is the primary condition for reliable pressure measurement during exercise tests.

The cuff must be applied directly on the skin, it may not be applied on top of clothing, paper, etc. Apply the cuff approx. **2 cm above the bend of the elbow**. The cuff should be **tight**, but it should not constrict blood vessels. The cuff **may not move** during the exercise test.

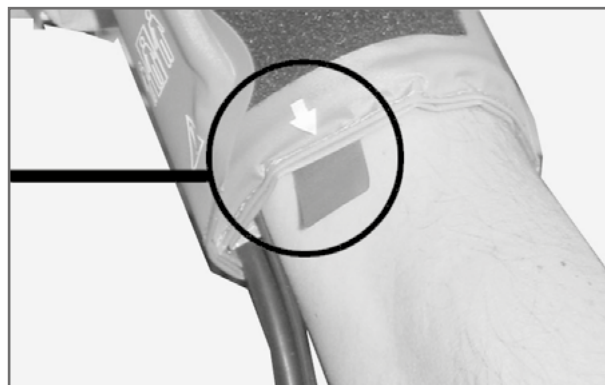

MICROPHONE PLACEMENT ON THE ARTERY

The cuff tab must be located below the metal clasp (see illustration at right).

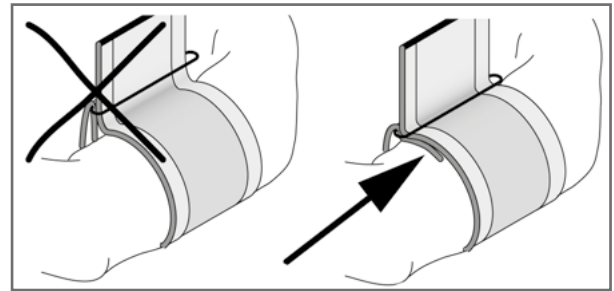

CORRECT CUFF POSITION (TAB)

CHECKING THE CUFF TUBING

Check that the cuff tubing does not knock against the patient's knee, when the patient is pedalling and the hand is on the handlebar.

Secure the cuff tubing with the Velcro tape attached to the handlebar.

Instruct your patient to move as little as possible during a blood pressure measurement and, in particular, to avoid excessive contractions of the muscles in the upper arm.



DISTANCE BETWEEN KNEE AND TUBING



CAUTION

- Patient Hazard •

Apply the cuff directly on the skin. Make sure that rolled up sleeves do not impede blood circulation in the upper arm. Loose cuffs will cause erroneous measurements; overtight cuffs may constrict blood vessels or cause skin lesions and hematomas.

- Incorrect Measurements •

A loose cuff would degrade the accuracy of the measurement. Therefore, the computer aborts the measurement, if a minimum pressure is not attained within a few seconds.



WARNING

- Patient Hazard •

If, by accident, an excessive pressure builds up inside the cuff, either remove the cuff immediately from the arm or disconnect the cuff tubing from the control terminal. The same measures are recommended, if the cuff does not deflate correctly.

SMARTSAT[®] SpO₂ MODULE

INTENDED PURPOSE

The reusable SMARTsat[®] pulse oximetry sensors are intended to be used for non-invasive continuous monitoring and/or random monitoring of the functional oxygen saturation of arterial hemoglobin (SpO₂) and pulse rate in adults and children, depending on the sensor type used.

SMARTsat[®] is intended for use in professional healthcare facilities and in sports medicine in compliance with the safety information.

FACTORS THAT MAY INFLUENCE READINGS

Physiological conditions, medical procedures, or external agents that may degrade pulse oximeter performance or affect the accuracy of the measurement include the following:

Ambient light:

If the ambient light level exceeds a limit of compensation SMARTsat[®] interrupts the measurement and sends out the status flag "Ambient light".

NOTICE

Shield the SpO₂ sensor application site with opaque material if the measurement is interrupted and the status flag "Ambient light" is send.

Motion artefacts:

The SMARTsat[®] algorithm suppresses the influence of motion on the SpO₂ and PR measurement. However long and continuous motion can lead to wrong measurements. SMARTsat[®] provides a Signal Quality and Motion indicator to inform the user if the measurement value is potentially incorrect.

NOTICE

*Check the sensor site and prevent motion artefacts if SMARTsat[®] detects bad signal quality, motion artefacts, interferences etc. (see SMARTsat[®] status flags) Dysfunctional hemoglobin (e.g. COHb, MetHb):
High concentration of dysfunctional hemoglobin, such as COHb or MetHb, which is not able to transport oxygen can falsify the measurement. The indicated result appears to be normal but the patient may be hypoxic.*

Intravascular dyes:

Taking medicine or other preparations that change blood color or the administration of intravascular dyes (such as methylene blue or indocyanine green, etc.) can drastically falsify the measurement results.

Other:

Other conditions that may degrade pulse oximeter performance or affect the accuracy of the measurement include:

- Incorrect applications of the sensor
- Externally applied coloring agents such as nail polish or artificial nails,
- Placement of the sensor on an extremity with blood flow restrictors (arterial catheters, blood pressure cuffs, infusing lines, etc.),
- Low perfusion, venous pulsations, anemia or low hemoglobin concentrations
- Cardiac dysrhythmia like extrasystole or atrial/ventricular fibrillation
- Electromagnetic interference and electrosurgical interference

STATUS MESSAGES

The SpO₂ module continuously monitors the sensor and the physiological conditions, and reports the status to the control terminal.

The status flags include:

Status Information	Reason
Connect sensor	Sensor is not connected
Sensor off patient	Sensor has been removed from the measurement site or slipped of the measurement site (finger or ear lobe)
Pulse search > 30 s	No pulse detected for more than 30 seconds. This could be due to no pulse being present or artifacts in the signal. No SpO ₂ or pulse rate values are transmitted.
Loss of pulse	No pulse is detected and therefore no value is displayed; typically due to prolonged bad signal quality. Alarm monitors should issue at least a medium priority alarm if this bit is set.
Ambient light	Ambient light level exceeds the limit of possible compensation. The measurement is interrupted and the flag is sent.
Param out of range	Vital parameter out of range: Measurement values are invalid because they are outside the specified measurement range. Possible reasons include the use of intravascular dyes.
Replace sensor	The sensor, its cable or the optical components are defective. The measurement is interrupted. Remove the sensor to reset the flag. Measurement is continued on connection of a new sensor.
SpO ₂ defect	Supply voltage out of range: The supply voltage provided to the module is outside of the specified range. Under these conditions the measurement values are potentially incorrect.

ALARM SYSTEM

The ergoselect bicycle ergometer does not have an alarm system for detecting a **physiological alarm status** (low SpO₂ or pulse rate values).

OPERATION

The ergometers of the ergoselect series are available with two versions of the control terminal whose functionalities differ.

The following sections describe the control and configuration of the ergometer.



Control terminal P



Control terminal K

CONTROL TERMINAL P

TURNING THE SYSTEM ON

You turn the ergometer on by pressing the power switch - the green indicator in the switch lights up.

The ergometer runs a self-test. Subsequently, the main menu displays.

NOTICE

- *Instruct the patient not to pedal while the ergometer is being turned on and during the self-test.*
- *Apply the blood pressure cuff to the patient AFTER the ergometer has been turned on and the self-test completed.*
- *The device can be configured to default to one of the operating modes. If this option is selected, the initial screen of the selected operating mode (e.g. Ergometry) will be displayed instead of the main menu. With the  key, you can display the main menu.*



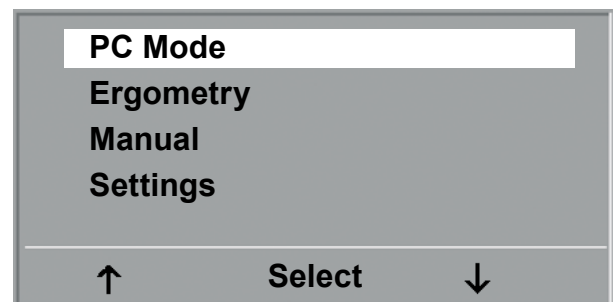

SELF-TEST SCREEN



MAIN MENU

The ergometer software is controlled with 5 keys:

 With this key you display the main menu or return to the previous menu level.

 With this key you initiate a blood pressure measurement. A measurement in progress can be aborted with the same key.

 The functions of these three softkeys change with the displayed menu - the key label describing the function is shown on the display.

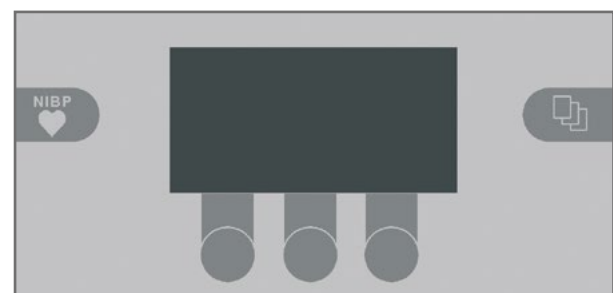

KEYPAD P

OPERATING MODES WITH CONTROL TERMINAL P

An ergoselect ergometer with a control terminal P supports the following operating modes:

PC MODE

An external device (e.g. stand-alone electrocardiograph, PC-based ECG system) controls the ergometer - no intervention at all is required at the ergometer.

ERGOMETRY

The ergometer runs an automatic exercise test - some of the corresponding test protocols are user-configurable and stored in the system (see chapter "Settings").

MANUAL

The ergometer is controlled manually, i.e., the user performs all load changes via the keypad.

SETTINGS

Used to configure the ergometer.

SPEED READOUT

At the top of the control terminal, there is a speed readout for the patient as well as three LEDs that inform the patient of the speed: too slow, too fast or correct.



The ranges for the respective speed ratings depend on the selected load (see "Technical Specifications").



SPEED READOUT

- 1 speed low (patient should pedal faster)
- 2 correct speed
- 3 speed high (= patient should pedal slower)

NOTICE

- If, during an exercise test, the speed drops below 30 RPM, the load readout starts blinking on the display.
- To reactivate the saddle height adjustment function, press  and the arrow keys will again be displayed.
- Additional blood pressure measurements can be initiated with .

PC Mode

Use the softkeys on the right and left (↑ ↓) to position the bar cursor on PC MODE and confirm the selection with SELECT.

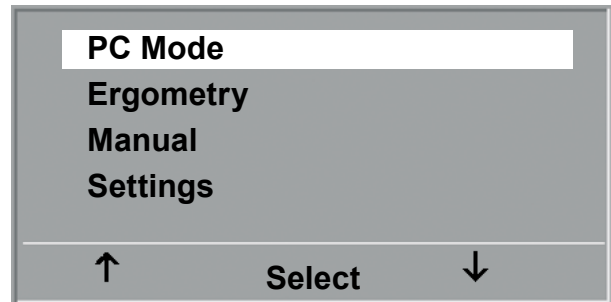

MAIN MENU

The display changes - the ergometer is waiting for commands from the external ECG unit.

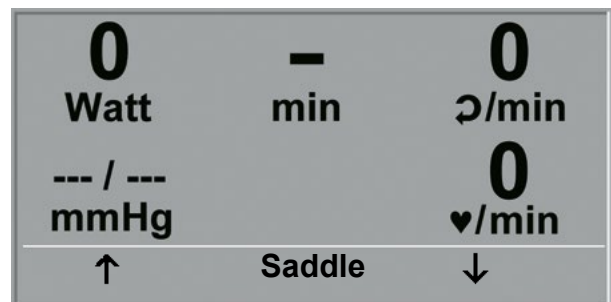

INITIAL SCREEN

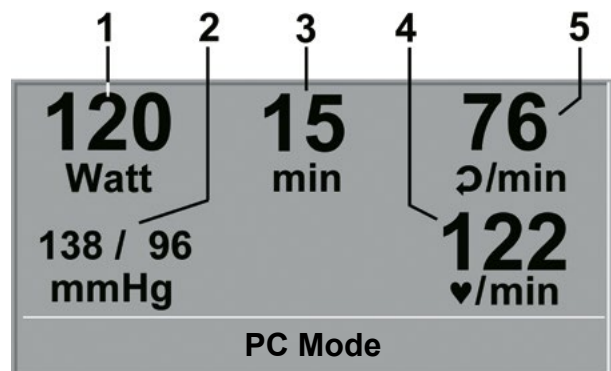

With the arrow keys, the saddle height can be electrically adjusted on the ergoselect 200 (on the ergoselect 400, these keys adjust the height of the drive unit).

As soon as the ergometer receives commands from the controlling ECG unit or PC, the exercise test will start and the corresponding values will be displayed.



The exercise test can only be terminated with the corresponding command from the controlling ECG unit.

NOTICE

- All functions are locked while the ergometer is operating in PC mode, except for the saddle height adjustment and the blood pressure key.
- To reactivate the saddle height adjustment function, press  and the arrow keys will again be displayed.
- Additional blood pressure measurements can be initiated with .

DISPLAY DURING EXERCISE TEST

- 1 current load in watts
- 2 most recent BP value (systolic/diastolic values) or cuff pressure during inflation and bar graph indicating microphone signal strength (see below)
- 3 duration of exercise test (min)
- 4 heart rate at the time of the BP measurement (BPM)
- 5 pedal speed (RPM)



ERGOMETRY

Use the softkeys on the right and left (↑ ↓) to position the bar cursor on ERGOMETRY and confirm the selection with SELECT.

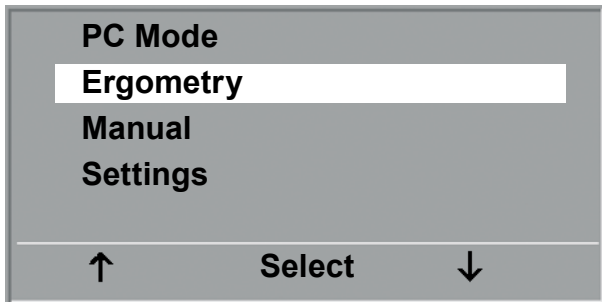

MAIN MENU

The stored test protocols available for selection will be displayed. There are five fixed protocols (protocols 1 to 5, see Appendix), whereas protocols 6 to 15 are user-programmable.

The protocol menu provides an overview of the test phases:

e.g.: **50 W / 2 min / 25 W**
 means: initial (basic) load 50 watts
 stage time 2 minutes
 load increment 25 watts

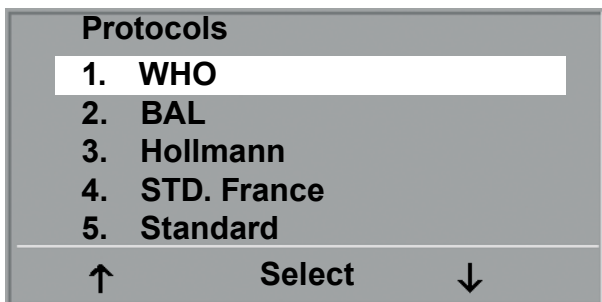

SELECTING AN EXERCISE TEST PROTOCOL

Use the softkeys on the right and left (↑ ↓) to position the bar cursor on one of the protocols and confirm the selection with SELECT.

The exercise test is started with the "Start" key, a blood pressure measurement at rest may precede the test (see "Settings").

When the basic load appears on the display (after approx. 15 seconds or upon termination of the blood pressure measurement) and the patient's RPM indicator blinks, the patient should start pedalling.

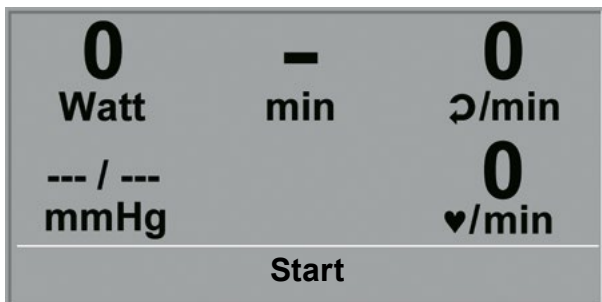

INITIAL EXERCISE TEST SCREEN



The internal protocol will now control the entire exercise test - the display always indicates the current values.

With the +5 W and -5 W keys, the current load can be changed at any time (in increments of +/-1 W up to +/-25 W, as configured).



SCREEN DISPLAY DURING THE TEST

NOTICE

- The saddle height (ergoselect 200) can be changed during an exercise test.
- To reactivate the saddle height adjustment function, press  and the arrow keys will again be displayed.
- Additional blood pressure measurements can be initiated with .

TERMINATING AN EXERCISE TEST

The exercise phase can be terminated manually at any time with the RECOVERY key.

The load will immediately be reduced to 25 watts, but a higher or lower value can be selected manually.

It is recommended that the patient continues to pedal in the recovery phase.

The END key in the middle will terminate the test.



RECOVERY PHASE

MANUAL

Use the softkeys on the right and left (↑ ↓) to position the bar cursor on MANUAL and confirm the selection with SELECT.

In this operating mode the user controls the entire exercise test by selecting the loads, stage times and by initiating blood pressure measurements.

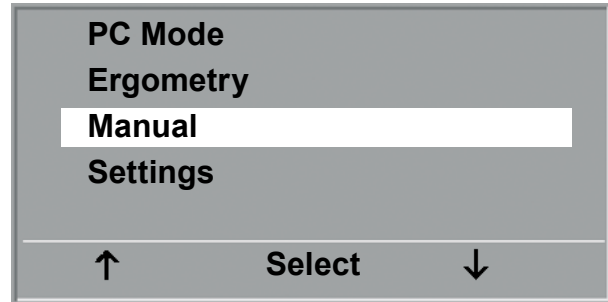

MAIN MENU

The exercise test is started with the "Start" key, afterwards the load can be set and changed with the +5 W and -5 W keys (in increments of +/-1 W up to +/-25 W, as configured).

Blood pressure measurements can be initiated with .



INITIAL SCREEN OF A MANUAL EXERCISE TEST

TERMINATING AN EXERCISE TEST

The exercise test can be terminated manually at any time with the END key located in the middle.

The load will immediately drop to 0 watt.

There is no recovery phase in the manual mode.

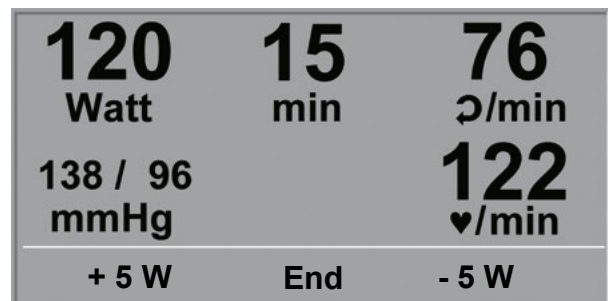

SCREEN DISPLAY DURING THE TEST

SETTINGS WITH CONTROL TERMINAL P

Some of the device settings are configurable to meet specific requirements. The settings will be saved and remain stored even when the ergometer is switched off.

Use the softkeys on the right and left (↑ ↓) to position the bar cursor on **SETTINGS** and confirm the selection with **SELECT**.

The configuration menu displays.

When all changes have been made, you can exit the configuration menu with the  key.

Use the softkeys on the right and left (↑ ↓) to position the bar cursor on the parameter to change and confirm the selection with **SELECT**.

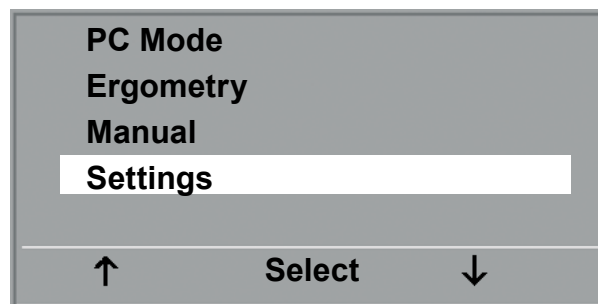

MAIN MENU

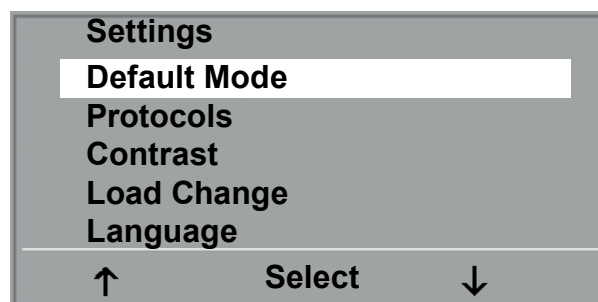

CONFIGURATION MENU

DEFAULT MODE

In this menu you choose the default mode activated when the ergometer is turned on. When first turned on, the ergometer will display this menu.

Use the softkeys on the right and left (↑ ↓) to position the bar cursor on your preferred default mode and save the selection with **SELECT**.

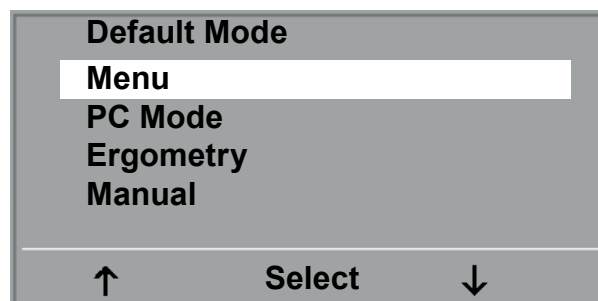

SELECTING THE DEFAULT MODE

PROTOCOLS

Protocols 6 - 15 are user-programmable (protocols 1 - 5 are fixed, see Appendix for protocol parameter details). Standard values for the following parameters can be entered:

- protocol type (step or ramp)
- initial load
- stage time
- load increment (load increase with each stage)

Use the softkeys on the right and left (↑ ↓) to position the bar cursor on the protocol to change (No. 6 - 15) and confirm the selection with **SELECT**.

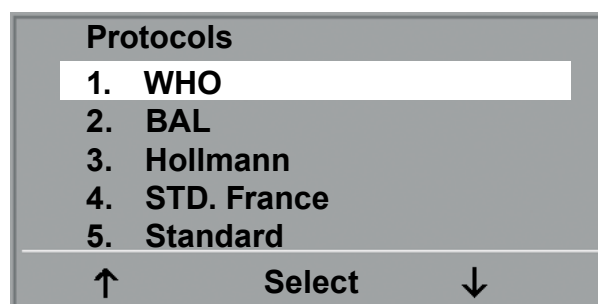

SELECTING THE EXERCISE TEST PROTOCOL TO EDIT

Use the softkeys \uparrow \downarrow to select the parameter to edit.

At Select, for example, you can choose the protocol type:

- Step (load increase in steps) or
- Ramp (continuous load increase).

Press SELECT to save the selected protocol type.

To cancel the selection, press the  key.

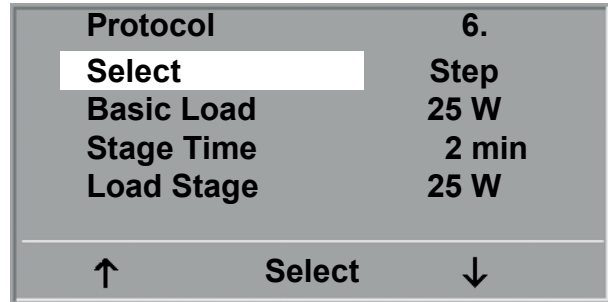

SELECTING THE PARAMETER TO EDIT

All other parameters are edited in the same way.

Using the arrow keys (\uparrow \downarrow), highlight a parameter and confirm the selection with SELECT: the corresponding value appears in reverse video and can be changed with the arrow keys \uparrow \downarrow .

Pressing SELECT will save the new value.
You exit the configuration with .

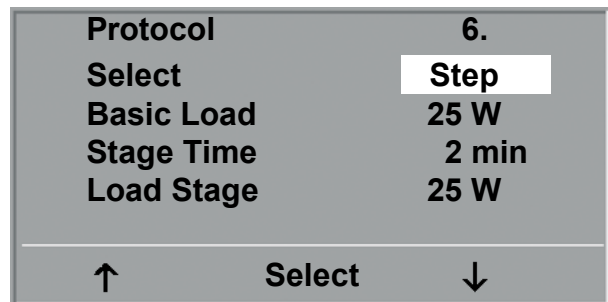

EDITING THE PARAMETER VALUE

CONTRAST

The display contrast is adjustable in the range from 0 to 100%.

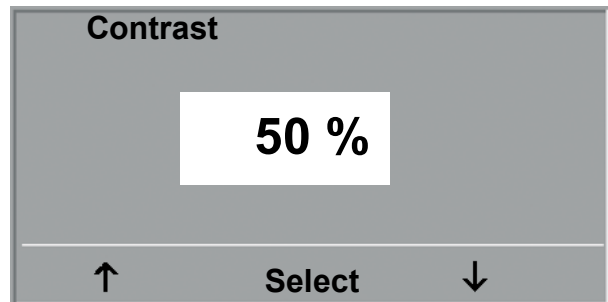

ADJUSTING THE DISPLAY CONTRAST

LOAD CHANGE

Here you determine the increments for each load change. Depending on your choice, each key press will change the load by +/- 1, 5, 10 und 25 Watts.

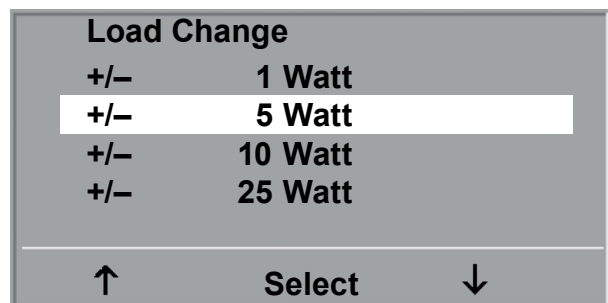

SELECTING THE INCREMENT FOR MANUAL LOAD CHANGES

LANGUAGE

The texts can be displayed in different languages.

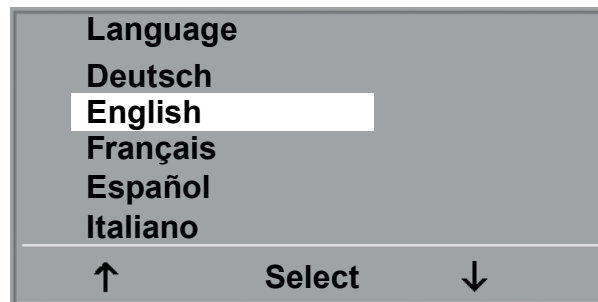

LANGUAGE MENU

BEEP

The audio signal emitted during blood pressure measurements can be turned on and off.

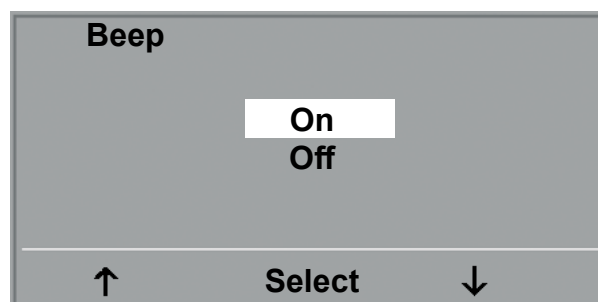

BEEP DURING BP MEASUREMENTS

SOFTWARE VERSION

Select this option to view the installed software version.

DATE/TIME

To begin with, you select DATE or TIME and confirm the selection. Then the value displayed in reverse video can be edited with the $\uparrow \downarrow$ keys and saved with SELECT.

The time is adjusted in the same way.
You exit the configuration with .

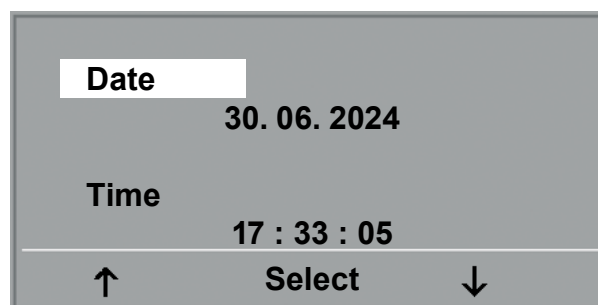

SETTING THE DATE

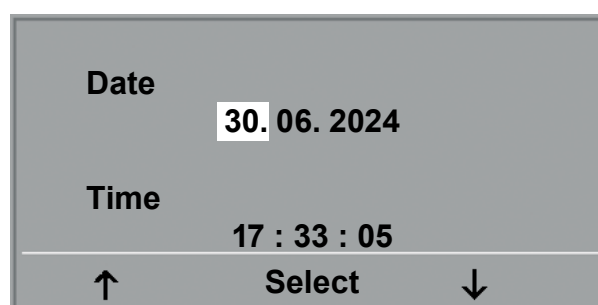

SETTING THE DAY

EKG TYPE

The selected EKG Type determines the communication method with the ECG recorder, PC-based ECG system, etc.

To prevent an accidental change of this setting, the menu is protected with a password.

Using the arrow keys, enter 003 and confirm the entry with SELECT.

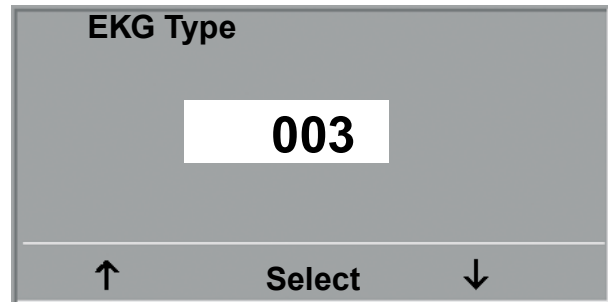

ENTERING THE EKG TYPE PASSWORD

All ergoselect ergometers support the following communication modes:

- Analog with pulse
Remote start mode; prior to each load change, the ergometer generates a control pulse and sends the corresponding data via the interface.
- Analog / Digital
An analog voltage controls the load - blood pressure measurements can be initiated with digital commands.
- Digital (default)
The communication with the ergometer is entirely controlled with digital commands.
- Analog IN-OUT
The entire communication (load control and BP measurements) is controlled with analog signals.
No digital data will be sent.

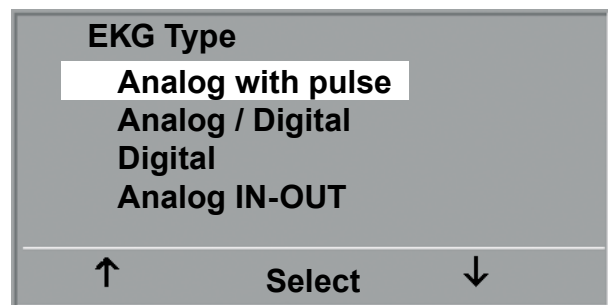

SELECTING THE ERGOMETER COMMUNICATION MODE

Select the communication mode and confirm with SELECT.

NOTICE

- *The EKG Type needs to be selected only when the ergometer is connected to an ECG unit. The selection is part of the installation procedure.*
- *The „Analog/Digital“ and „Digital“ communication is only possible when PC Mode is selected from the main menu or when this is the default mode.*

RPM

Here you determine the RPM limits. When these limits are exceeded, the LEDs for high or low speed (RPM) will illuminate.

Select the value to change (Min. or Max.) and confirm with SELECT.

Using the arrow keys, change the value and save the new value with SELECT.

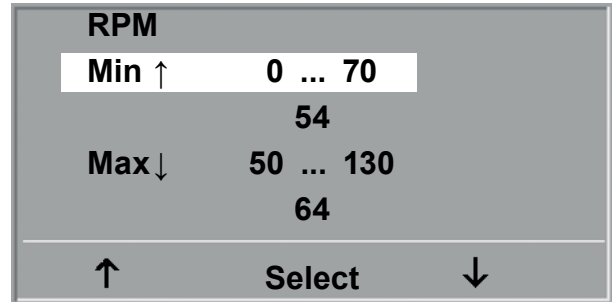

SETTING THE RPM LIMIT VALUES

NOTICE

- *The limits selected in this menu only apply to the load range between 6 and 150 watts. At higher loads the RPM limits automatically adapt to the respective loads:*

<i>Load (watts)</i>	<i>Green RPM range (1/min)</i>
6 - 150	54 - 64 (adjustable)
151 - 250	58 - 65
251 - 350	68 - 75
351 - 450	78 - 85
451 - 550	88 - 95
551 - 650	98 - 105
651 - 750	108 - 115
751 - 850	118 - 125
851 - 950	> 125
951 - 999	> 130

PULSE DISPLAY

The pulse readout on the display can be turned off.

CONTROL TERMINAL K

TURNING THE SYSTEM ON

You turn the ergometer on by pressing the power switch - the green indicator in the switch lights up. The ergometer runs a self-test. Subsequently, the main menu displays.

NOTICE

- *Instruct the patient not to pedal while the ergometer is being turned on and during the self-test.*
- *Apply the blood pressure cuff to the patient AFTER the ergometer has been turned on and the self-test completed.*
- *The device can be configured to default to one of the operating modes. If this option is selected, the initial screen of the selected operating mode (e.g. Ergometry) will be displayed instead of the main menu. With the  key, you can display the main menu.*



**ergoline
GmbH**

Selftest running

SELF-TEST SCREEN

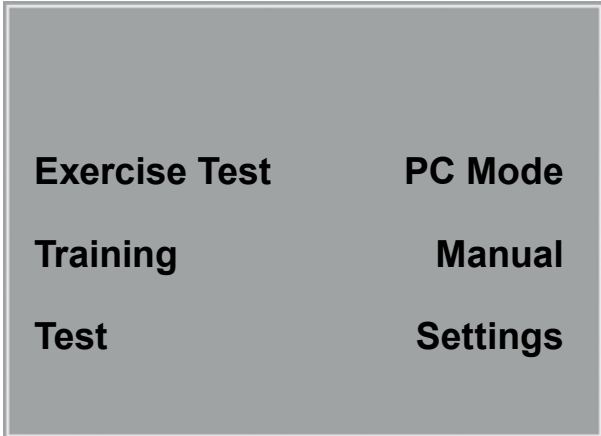

Exercise Test **PC Mode**

Training **Manual**

Test **Settings**

MAIN MENU

The ergometer software is controlled with 8 keys:

 With this key you display the main menu or return to the previous menu level.

 With this key you initiate a blood pressure measurement. A measurement in progress can be aborted with the same key.

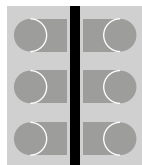

The functions of these six softkeys change with the displayed menu - the key label describing the function is shown on the display.

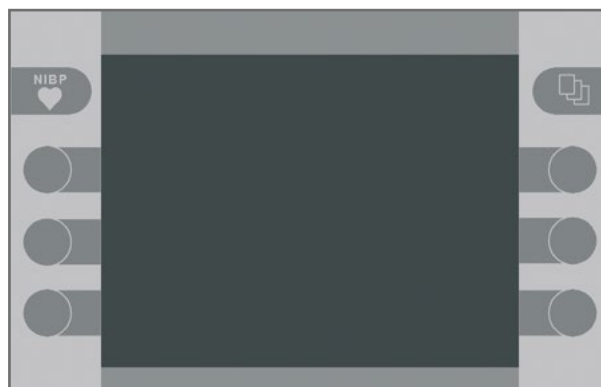

KEYPAD K

OPERATING MODES WITH CONTROL TERMINAL K

An ergoselect ergometer with a control terminal K supports the following operating modes:

PC MODE

An external device (e.g. stand-alone electrocardiograph, PC-based ECG system) controls the ergometer - no intervention at all is required at the ergometer.

ERGOMETRY

The ergometer runs an automatic exercise test - some of the corresponding test protocols are user-configurable and stored in the system (see chapter "Settings").

TRAINING

Ten different training protocols with warm-up, exercise and recovery phases can be custom-configured (see chapter "Settings").
A POLAR receiver is integrated in the ergometer and provides the relevant data for heart-rate controlled training sessions.

TEST

Integrated test protocols (steep ramping test, PWC tests) allow an assessment of the physical fitness.

MANUAL

The ergometer is controlled manually, i.e., the user performs all load changes via the keypad.

SETTINGS

Used to configure the ergometer.

SPEED READOUT

At the top of the control terminal, there is a speed readout for the patient as well as three LEDs that inform the patient of the speed: too slow, too fast or correct.



The ranges for the respective speed ratings depend on the selected load (see "Technical Specifications").



SPEED READOUT

- 1 speed low (patient should pedal faster)
- 2 correct speed
- 3 speed high (= patient should pedal slower)

NOTICE

- If, during an exercise test, the speed drops below 30 RPM, the load readout starts blinking on the display.
- To reactivate the saddle height adjustment function, press  and the arrow keys will again be displayed.
- Additional blood pressure measurements can be initiated with .

PC MODE

When the PC Mode key has been pressed, the screen appears as shown at right. The ergometer is waiting for commands from the external ECG unit.

With the arrow keys, the saddle height can be electrically adjusted on the ergoselect 200 (on the ergoselect 400, these key adjust the height of the drive unit).

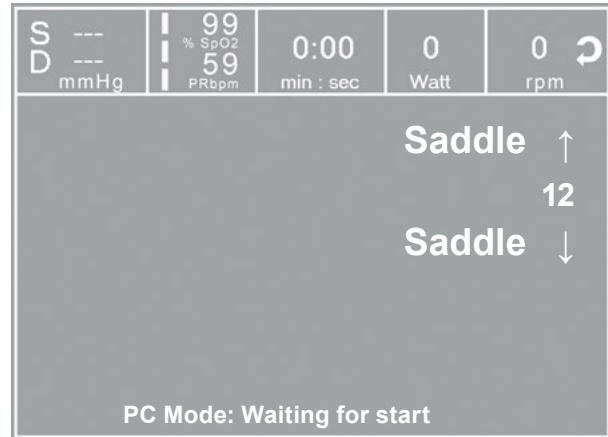



INITIAL SCREEN IN PC MODE

As soon as the ergometer receives commands from the controlling ECG unit or PC, the exercise test will start and the corresponding values will be displayed.

The exercise test can only be terminated with the corresponding command from the controlling ECG unit.

NOTICE

- All functions are locked while the ergometer is operating in PC mode, except for the saddle height adjustment and the blood pressure key.
- To reactivate the saddle height adjustment function, press  and the arrow keys will again be displayed.
- Additional blood pressure measurements can be initiated with .

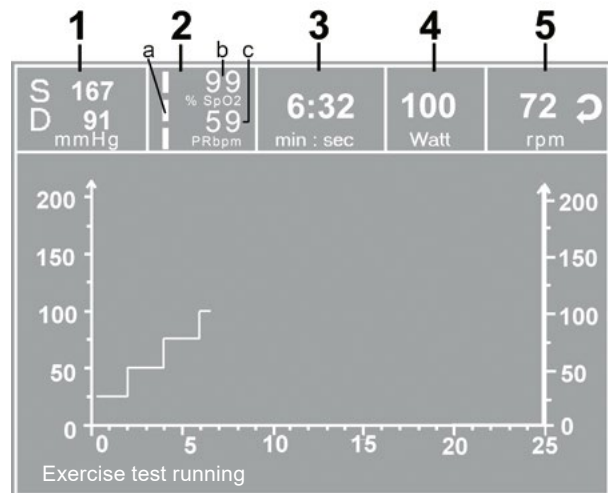

DISPLAY DURING EXERCISE TEST

- 1 most recent BP value (systolic/diastolic pressures) or cuff pressure during inflation and bar graph indicating microphone signal strength (see below)
- 2 a SpO₂ signal quality
1 bar: 1 – 30 %
2 bars: 31 – 60 %
3 bars: 61 – 100 %
- 2 b oxygen saturation SpO₂ (% SpO₂)
- 2 c pulse rate frequency PR of SpO₂ / blood pressure or heart rate HR of ECG / chest strap (bpm / 1/min)
- 3 duration of exercise test (minutes:seconds)
- 4 current load in watts
- 5 pedal speed (RPM)



ERGOMETRY

The ergometer is controlled by an internally stored protocol.

Pressing the "Ergometry" key will display the test protocol used last.

Press the "Start" key to re-start the protocol, or press the "Select" key to display the protocol parameters or to switch to another test protocol.

There are five fixed protocols (protocols 1 - 5, see Appendix), whereas protocols 6 - 15 are user-programmable.

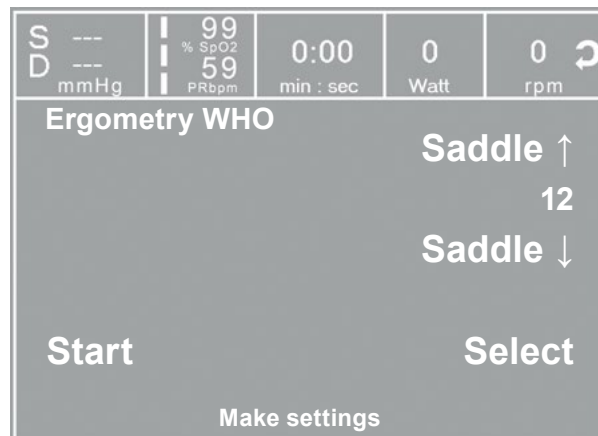

INITIAL SCREEN OF AN EXERCISE TEST

With the arrow keys you can display the test protocol. With "Select" you confirm the selection.

The selected exercise test is started with the "Start" key, a blood pressure measurement at rest may precede the test (see "Settings").

The display changes to the exercise test screen, where load and heart rate are represented both by numeric values and waveforms.

When the basic load appears on the display (after approx. 15 seconds or upon termination of the blood pressure measurement) and the patient's RPM indicator blinks, the patient should start pedalling.

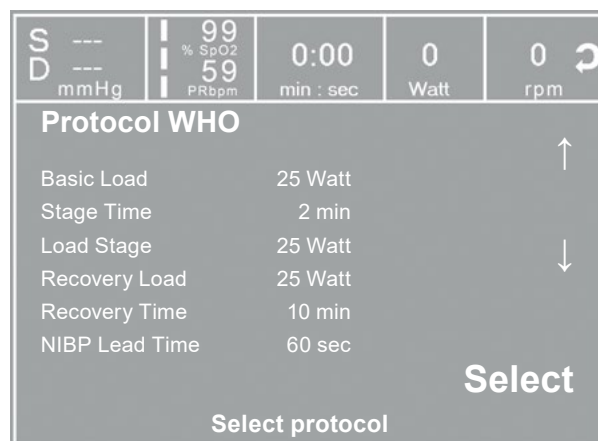

SELECTING THE TEST PROTOCOL

The internal protocol will now control the entire exercise test - the display always indicates the current values.

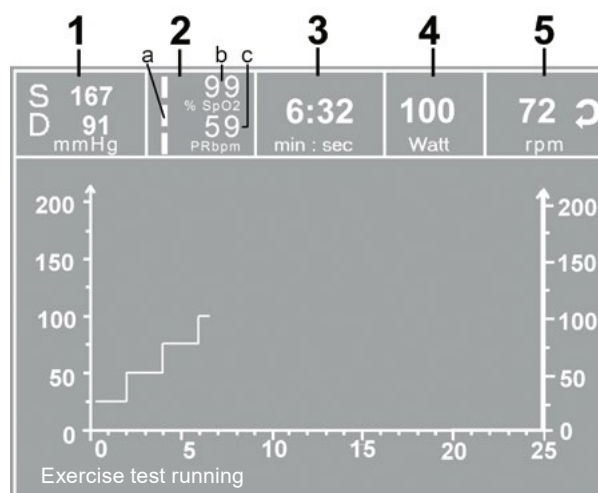

DISPLAY DURING EXERCISE TEST

- 1 most recent BP value (systolic/diastolic pressures) or cuff pressure during inflation
- 2 SpO₂ parameters (see page 38)
- 3 duration of exercise test (minutes:seconds)
- 4 current load in watts
- 5 pedal speed (RPM)

ADJUSTMENTS DURING THE EXERCISE TEST

Press the  key to display the configuration menu.

This is what you can do during the test

- increase or decrease the current load in increments (adjustable between 1 watt and 25 watts),
- hold the current load,
- end the exercise phase and advance to the recovery phase,
- terminate the test.

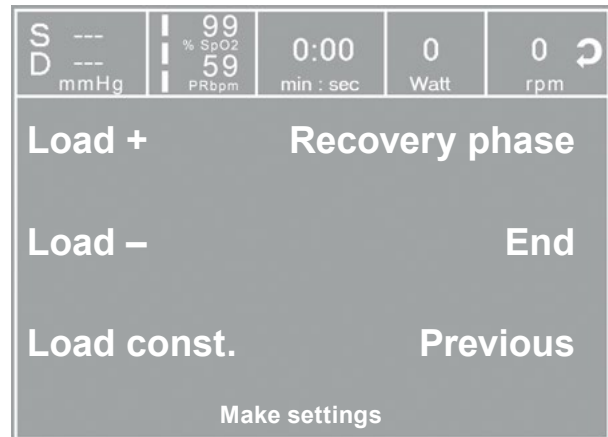

CONFIGURATION MENU I

Pressing  again displays another menu where you can change the saddle height and the display mode (see "PC Mode").

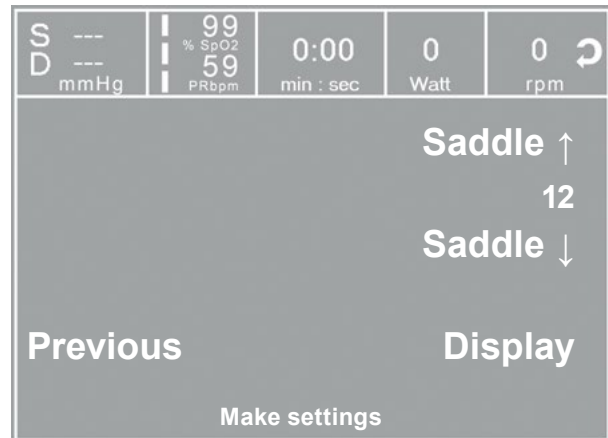

CONFIGURATION MENU II

TERMINATING THE TEST

Once the full protocol has been completed, the test will be terminated.

However, it is possible at any time to manually terminate the test or switch to the recovery phase (see above).

MANUAL

In this operating mode the user controls the entire exercise test by selecting the loads, stage times and by initiating blood pressure measurements.

The exercise test is started with the "Start" key, afterwards the load can be set and changed with the [Load +] and [Load -] keys (in increments of 1 W up to 25 W, as configured).

Blood pressure measurements can be initiated with .

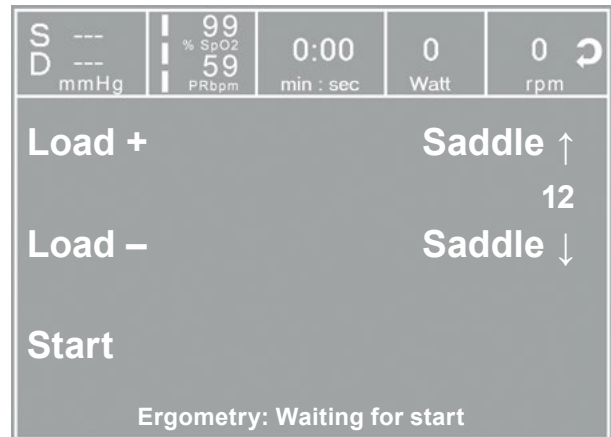

SCREEN DISPLAY IN MANUAL MODE

TERMINATING AN EXERCISE TEST

The exercise test can be terminated manually at any time with the END key located in the middle.

The load will immediately drop to 0 watt.

There is no recovery phase in the manual mode.

TRAINING

Cardiologic training sessions can be performed with ergo-select ergometers equipped with control terminal K. For a detailed description of the protocols, please refer to the Appendix.

Pressing the "Training" key will display the training protocol used last.

Press the "Start" key to re-start the protocol, or press the "Select" key to display the protocol parameters or to switch to another training protocol.

All training protocols 1 - 10 are user-configurable (see "Settings for Control Terminals K").

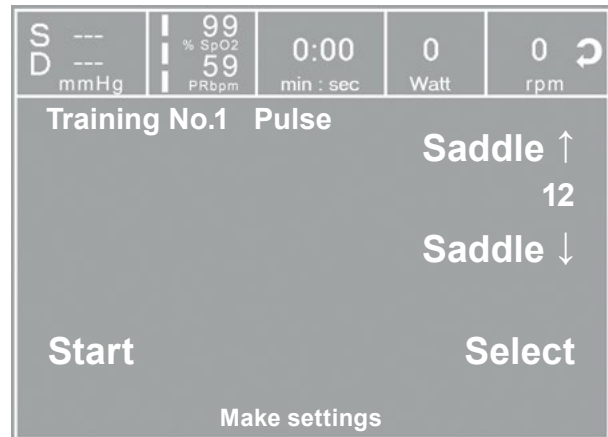

INITIAL SCREEN OF THE TRAINING SESSION

Use the arrow keys to display the protocol to use and the corresponding parameters. Confirm the selection with the "Select" key.

You initiate the training session with the "Start" key.

The display changes to the training session screen, where load and heart rate are represented both by numeric values and by waveforms.

When the basic load appears on the display (after approx. 15 seconds or upon termination of the blood pressure measurement) and the patient's RPM indicator blinks, the patient should start pedalling.

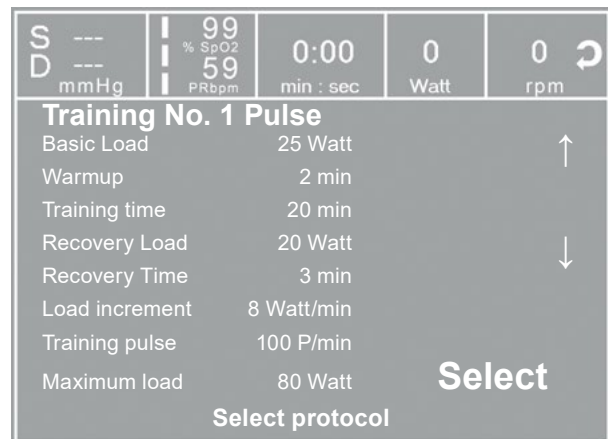

SELECTING THE TRAINING PROTOCOL

The internal protocol will now control the entire training session - the display always indicates the current values.

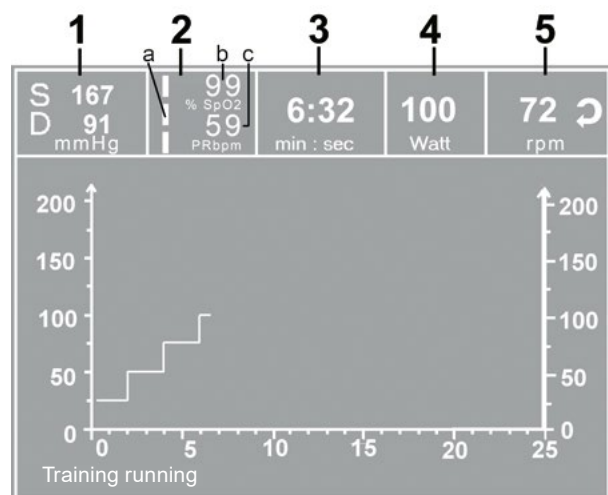

DISPLAY DURING EXERCISE TEST

- 1 most recent BP value (systolic/diastolic pressures) or cuff pressure during inflation
- 2 SpO₂ parameters (see page 38)
- 3 duration of exercise test (minutes:seconds)
- 4 current load in watts
- 5 pedal speed (RPM)

ADJUSTMENTS DURING THE TRAINING SESSION

Press the  key to display the configuration menu.

This is what you can do during the training session

- end the training session and advance to the recovery phase,
- directly terminate the training session,
- change the display mode (see "PC Mode").



CONFIGURATION MENU

TRAINING WITH CHIP CARD

As an alternative to the training protocols saved in the ergometer, it is possible to load training protocols from the chip card.

The training protocols are saved to the chip card by means of a PC program ("ergoline opticare professional" or "ergoline opticare basic").

Upon completion of the training session, the entire procedure (incl. load and heart rate waveforms) is saved to the chip card and can be reviewed and analyzed at the PC.

STARTING THE CHIP CARD TRAINING SESSION

Select the "Training" mode and insert the chip card into the card reader (on the side of the control terminal).

The ergometer switches to the chip card mode and reads the data stored on the card.

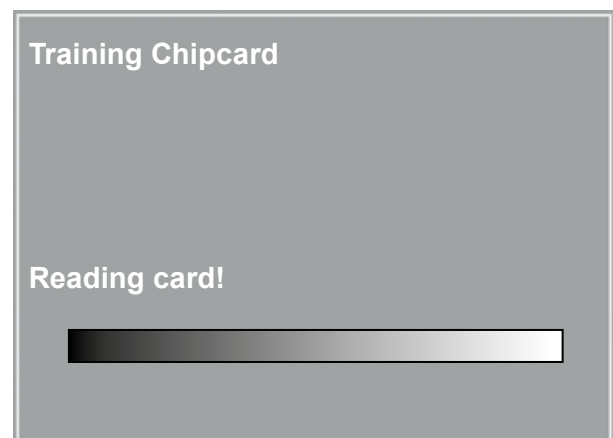

READING THE CHIP CARD DATA

The name and the weight stored on the card are displayed.

You can use the arrow keys to enter the current weight.

Press the "Next" key and the initial screen will display.
You can initiate the displayed training protocol or select another protocol from the chip card.

The chip card training session proceeds in the same way as the exercise tests stored in the ergometer.

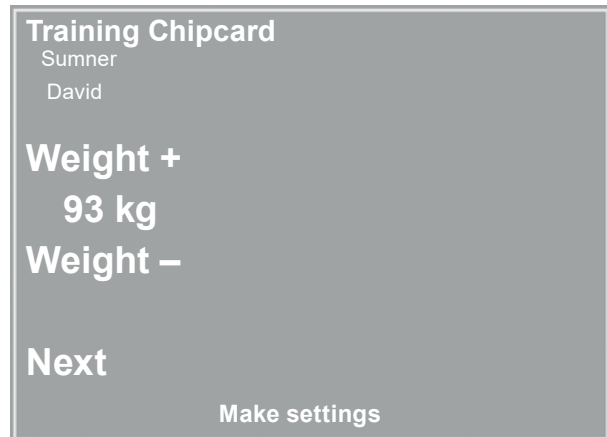

ENTERING THE WEIGHT

TERMINATING THE TRAINING SESSION

After termination of the training session (automatic termination when the programmed recovery phase has been completed, or manual termination) the test subject can state how the test was perceived (BORG scale).

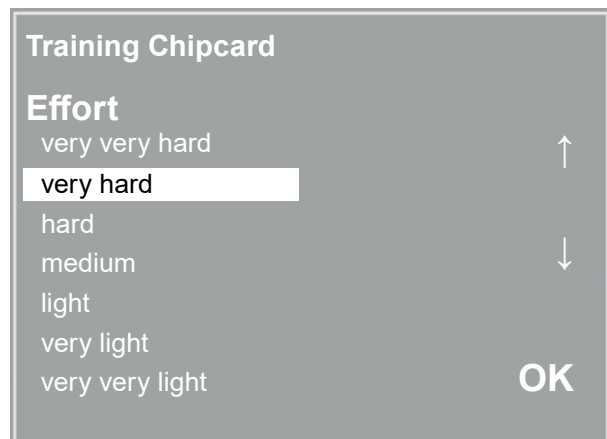

ENTERING THE BORG VALUE

Subsequently all training data are written to the chip card and are then available for analysis with a special program (e.g. opticare basic).

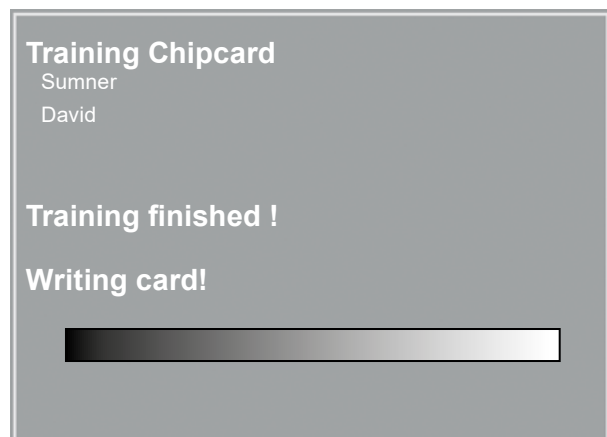

WRITING TO THE CHIP CARD

SETTINGS FOR CONTROL TERMINALS K

Some of the device settings are configurable to meet specific requirements. The settings will be saved and remain stored even when the ergometer is switched off.

Select **SETTINGS** to display the configuration menu.

When all changes have been made, you can exit the configuration menu with the  key.

Use the softkeys (↑ ↓) to position the bar cursor on the parameter to change and confirm the selection with **SELECT**.

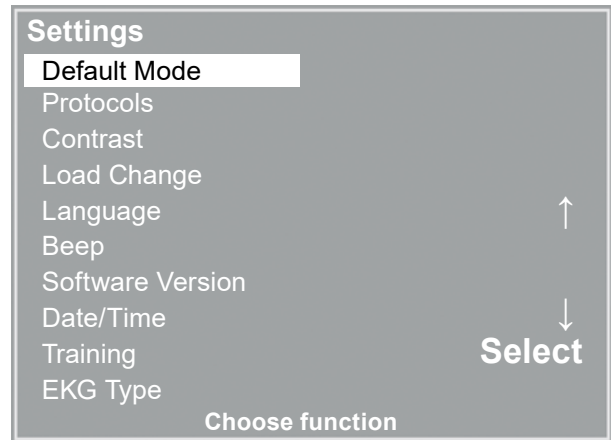

CONFIGURATION MENU

DEFAULT MODE

In this menu you choose the default mode activated when the ergometer is turned on. When first turned on, the ergometer will display this menu.

Use the softkeys (↑ ↓) to position the bar cursor on your preferred default mode and save the selection with **SELECT**.

PROTOCOLS

Protocols 6 - 15 are user-programmable (protocols 1 - 5 are fixed, see Appendix for protocol parameter details). Standard values for the following parameters can be entered:

- test protocol type (step/ramp)
- initial load
- stage time
- load increment (load increase with each stage)
- NIBP lead time (blood pressure measurement)
- recovery load
- recovery time

Use the softkeys (↑ ↓) to position the bar cursor on the protocol to change (No. 6 - 15) and confirm the selection with **SELECT**.

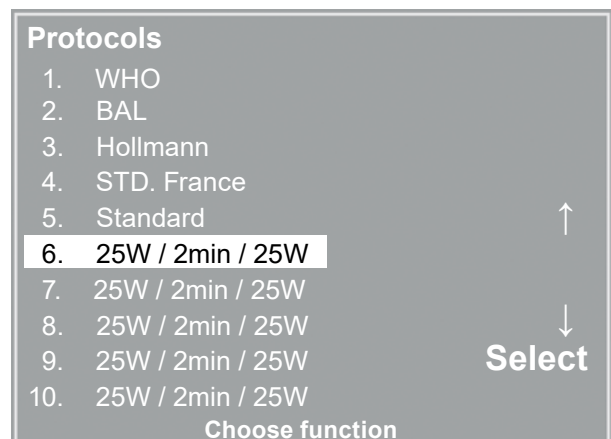

SELECTING THE EXERCISE TEST PROTOCOL TO EDIT

Use the softkeys \uparrow \downarrow to select the parameter to edit.

At Select, for example, you can choose the protocol type:

- Step (load increase in steps) or
- Ramp (continuous load increase).

Press SELECT to save the selected protocol type.

To cancel the selection, press the  key.

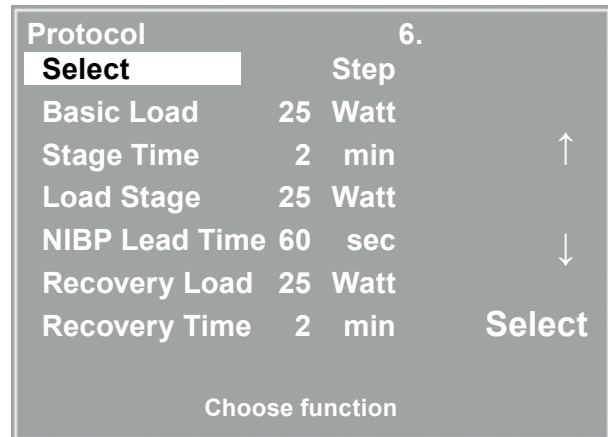

SELECTING THE PARAMETER TO EDIT

All other parameters are edited in the same way.

Using the arrow keys (\uparrow \downarrow), highlight a parameter and confirm the selection with SELECT: the corresponding value appears in reverse video and can be changed with the arrow keys \uparrow \downarrow .

Pressing SELECT will save the new value.

You exit the configuration with .

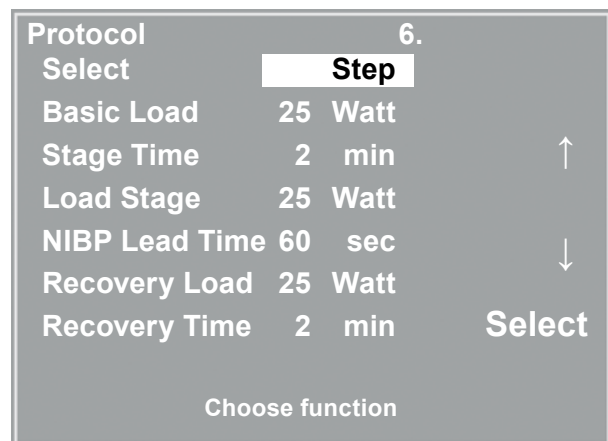

EDITING THE PARAMETER VALUE

CONTRAST

The display contrast is adjustable in the range from 0 to 100%.

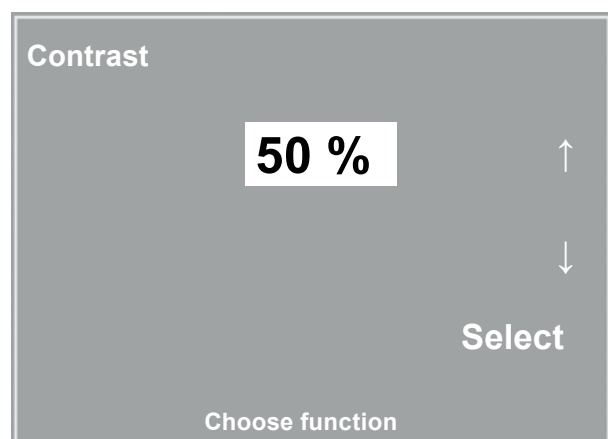

EDITING THE PARAMETER VALUE

LOAD CHANGE

Here you determine the increments for each load change. Depending on your choice, each key press will change the load by +/- 1, 5, 10 und 25 watts.

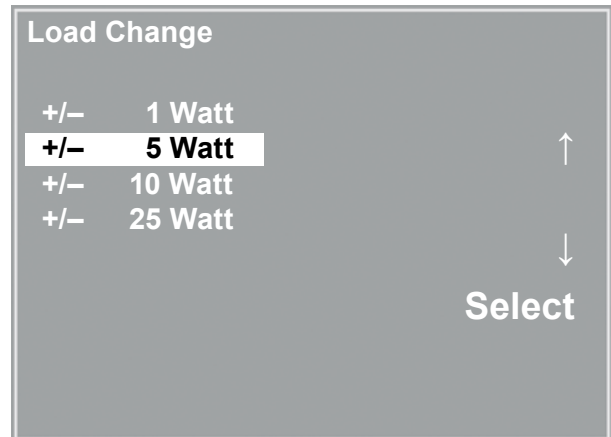

SELECTING THE INCREMENT FOR MANUAL LOAD CHANGES

LANGUAGE

The texts can be displayed in different languages.

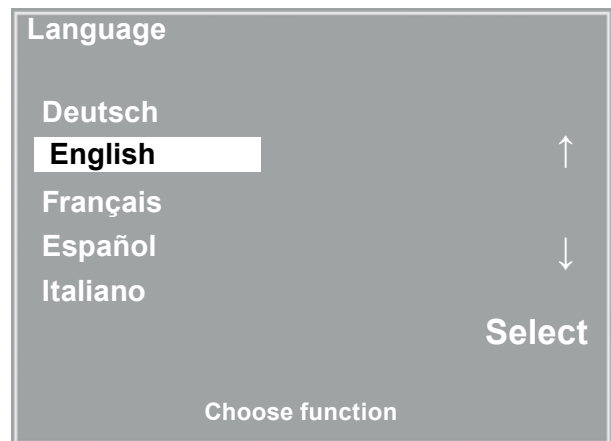

LANGUAGE MENU

BEEP

The audio signal emitted during blood pressure measurements can be turned on and off.

SOFTWARE VERSION

Select this option to view the ergometer's installed software version.

DATE/TIME

To begin with, you select DATE or TIME and confirm the selection.

Then the value displayed in reverse video can be edited with the ↑ ↓ keys and saved with SELECT.

The time is set in the same way.

You exit the configuration with .

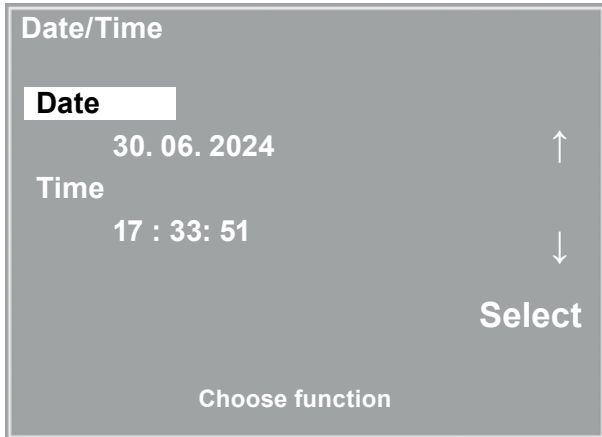

Date/Time

Date
30. 06. 2024

Time
17 : 33: 51

↑
↓

Select

Choose function

SETTING THE DATE

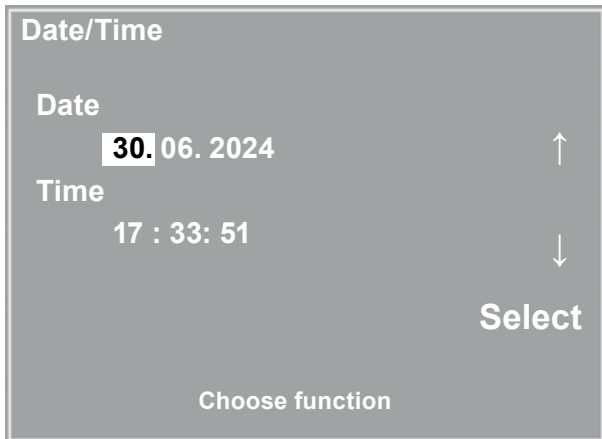

Date/Time

Date
30. 06. 2024

Time
17 : 33: 51

↑
↓

Select

Choose function

CHANGING THE DATE

TRAINING

Ten training protocols consisting of warmup, training and recovery phase are user-configurable. Depending on the selected training mode (pulse, constant, interval), there will be different parameters to define for the training phase:

First of all you select and confirm the protocol you wish to configure.

Then you select the parameters with the arrow keys (↑ ↓) as usual and edit them.

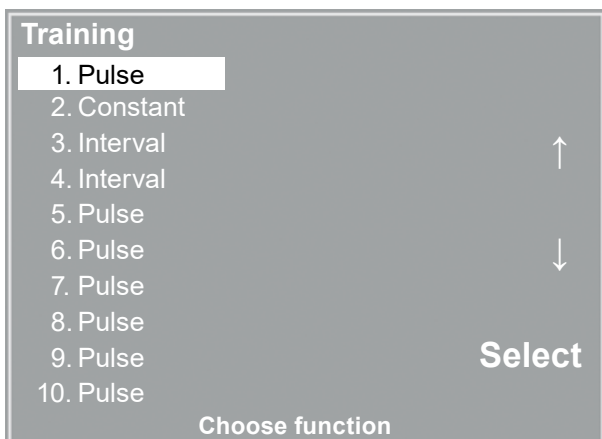

Training

1. **Pulse**

2. Constant

3. Interval

4. Interval

5. Pulse

6. Pulse

7. Pulse

8. Pulse

9. Pulse

10. Pulse

↑
↓

Select

Choose function

SELECTING THE EXERCISE TEST PROTOCOL TO EDIT

For all training modes (pulse, constant load and interval), the warmup phase, the duration of the training session and the recovery phase are defined first. Depending on the selected training mode, you can edit the corresponding parameters afterwards:

- **Pulse-controlled training:**
 Training pulse: 40 - 250 1/min
 Maximum load: 1 - 999 Watt
- **Constant load:**
 Training load: 1 - 999 Watt
- **Interval training:**
 Load Stage 1: 1 - 999 Watt
 Stage Time 1: 10 - 300 sec
 Load Stage 2: 1 - 999 Watt
 Stage Time 2: 10 - 300 sec

Training			
Select	Pulse		
Basic Load	20	Watt	
Warmup	2	min	↑
Training time	20	min	
Recovery Load	20	Watt	
Recovery Time	3	min	↓
Load increment	8	W/min	
Training pulse	100	1/min	
Maximum load	50	Watt	Select
Choose function			

EDITING THE TRAINING PROTOCOL

EKG TYPE

The selected EKG Type determines the communication method with the ECG recorder, PC-based ECG system, etc.

To prevent an accidental change of this setting, the menu is protected with a password.

Using the arrow keys, enter 003 and confirm the entry with SELECT.

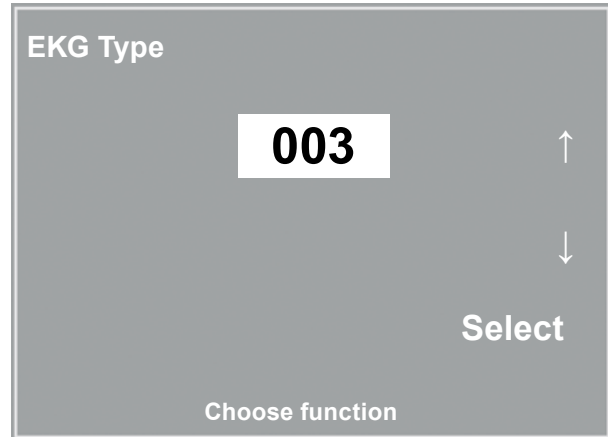

ENTERING THE EKG TYPE PASSWORD

All ergoselect ergometers support the following communication modes:

- Analog with pulse
Remote start mode; prior to each load change, the ergometer generates a control pulse and sends the corresponding data via the interface.
- Analog / Digital
An analog voltage controls the load - blood pressure measurements can be initiated with digital commands.
- Digital (default)
The communication with the ergometer is entirely controlled with digital commands.
- Analog IN-OUT
The entire communication (load control and BP measurements) is controlled with analog signals.
No digital data will be sent.

Select the communication mode and confirm with SELECT.

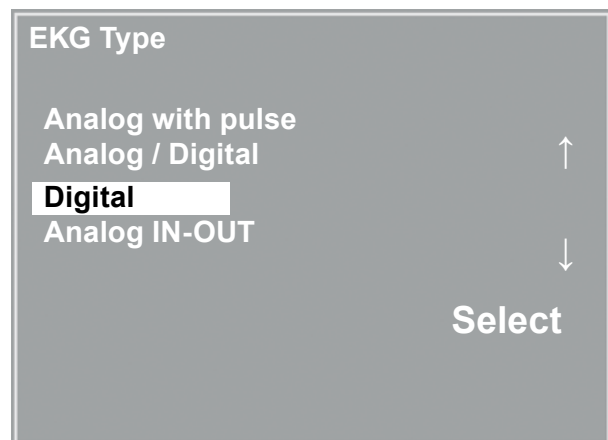

SELECTING THE ERGOMETER COMMUNICATION MODE

NOTICE

- *The EKG Type needs to be selected only when the ergometer is connected to an ECG unit. The selection is part of the installation procedure.*
- *The „Analog/Digital“ and „Digital“ communication is only possible when PC Mode is selected from the main menu or when this is the default mode.*

RPM

Here you determine the RPM limits. When these limits are exceeded, the LEDs for high or low speed (RPM) will illuminate.

Select the value to change (Min. or Max.) and confirm with SELECT.

Using the arrow keys, change the corresponding value and save the new value with SELECT.

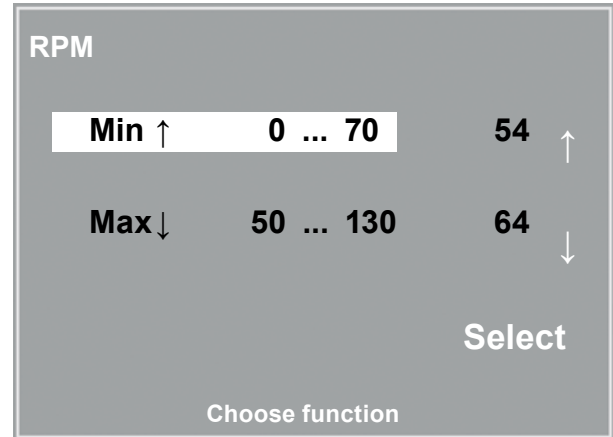

NOTICE

- *The limits selected in this menu only apply to the load range between 6 and 150 watts. At higher loads the RPM limits automatically adapt to the respective loads:*

<i>Load (watts)</i>	<i>Green RPM range (1/min)</i>
6 - 150	54 - 64 (adjustable)
151 - 250	58 - 65
251 - 350	68 - 75
351 - 450	78 - 85
451 - 550	88 - 95
551 - 650	98 - 105
651 - 750	108 - 115
751 - 850	118 - 125
851 - 950	> 125
951 - 999	> 130

SETTING THE RPM LIMIT VALUES

PULSE DISPLAY

The pulse readout on the display can be turned off.

CLEANING, DISINFECTION AND GENERAL HYGIENE MEASURES

The document "Cleaning and Disinfection ergoline Medical Devices" (Part No. 201000641000) in its most recent version is also part of this manual. This document is exclusively made available for download from the ergoline website www.ergoline.com.

DISINFECTION

The cleaning of the SpO₂ sensors from "bluepoint medical GmbH & Co. KG" is described in the instructions for use "IFU-01-02-0001". This is enclosed with every sensor.

GENERAL PRODUCT INFORMATION

CHECKS BEFORE EACH USE

Before each use, visually inspect the device for signs of damage.

If you detect damages or impaired functions which may result in a hazard to the patient or the operator, the device must be repaired before it can be used again.

TECHNICAL SAFETY INSPECTIONS AND TECHNICAL INSPECTIONS OF THE MEASURING SYSTEM

The technical safety inspections and the inspections of the measuring system must be completed every two years according to the rules of the art by a Service Engineer authorized by ergoline.

Similarly, the automatic sphygmomanometer in the control terminal must be checked and calibrated by an authorized specialist every two years to fulfill legal requirements. The date of the next inspection is indicated on the inspection sticker attached next to the type plate on the ergometer.

DISPOSAL

Do not dispose the product described in this Operator Manual as unsorted municipal waste. It must be collected separately.

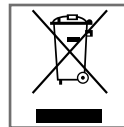

Please contact the authorized manufacturer ergoline GmbH to obtain information concerning the decommissioning of your equipment. There is no proper waste management, proper disposal is documented by ergoline GmbH.

ACCESSORIES / COMPATIBLE DEVICES

Part number		
705786	Pedals, extra wide, with comfort pedal straps (set)	
705944	Comfort pedal straps, with ratchet (set)	
705905	Pedal cranks, adjustable	consisting of: – pedal crank (set, left +right) adjustment range of 75 to 175 mm
705942	Pedal cranks, adjustable w/o tools	adjustment range of 75 to 175 mm
705308	Quick release adapter (w/o saddle)	
707259	Horizontal seat adjustment	consisting of: – special attachment (with quick release) for seat post and horizontal adjustment options – universal saddle mounting max. patient weight 150 kg!
471107	Racing saddle with standard receptacle (Ø 22 mm)	
471110	Pediatric seat with standard receptacle (Ø 22 mm)	
705024	Standard saddle with standard receptacle (Ø 22 mm)	
705300	Anti-tipping device for ergoselect 1, 100, 200 & white stabilizer plate, width 85 cm	
705306	Foot bracket for ergoselect (bracket/plug anchor)	
705088	Blood pressure cuff, metal D-ring, standard	(arm circumference 24 to 32 cm / width 13 cm)
705089	Blood pressure cuff, metal D-ring, standard, 2-meter tube	(arm circumference 24 to 32 cm / width 13 cm)
705090	Blood pressure cuff, metal D-ring, large	(arm circumference 32 to 42 cm / width 15.5 cm)
705091	Blood pressure cuff, metal D-ring, large, 2-meter tube	(arm circumference 32 to 42 cm / width 15.5 cm)
705092	Blood pressure cuff, small	(arm circumference 17 to 26 cm / width 9 cm)
701216	SoftCap® Sensor, SC7500 (REF 6020132004)	SpO ₂ sensor with 1.20 m cable length
701225	SoftCap® Sensor medium, SCM7500 (REF 6020132010)	SpO ₂ sensor with 1.20 m cable length
701213	SpO ₂ extension cable 1.20 m	
705093	Connecting cable ergoselect to PC (5 m)	consisting of: – connection cable 5 m (DSUB 9 <-> DSUB 9)
705094	Connecting cable ergoselect to PC (12 m)	consisting of: – connection cable 12 m (DSUB 9 <-> DSUB 9)
705305	USB adapter (USB <-> RS-232)	
705464	USB cable for ergoselect Series II / III (5 m)	

TECHNICAL SPECIFICATIONS

ERGOMETER

Model	modular ergometer system ergoselect models ergoselect 100 P / K, ergoselect 150 P / K, ergoselect 200 P / K
Operating Mode	continuous operation
Power	100 - 240 V / 50 - 60 Hz (100 VA max.) specification power cord US: SJT 2x18AWG 125 V / 7 A specification internal backup battery: IEC: CR 2032 /3V 230 mAh
Braking Principle	computer-controlled eddy current brake with torque measurement; speed independent to DIN VDE 0750-238
Load Range	6 - 999 watts, speed independent (see diagrams)
Speed Range	30 to 130 RPM
Deviation of Measured Load	to DIN VDE 0750-238
Load Increments	user programmable
Internal Protocols	Control Terminal P: <ul style="list-style-type: none">• 5 fixed incremental exercise test protocols (e.g. WHO)• 10 user-programmable protocols• manual load control Control Terminal K: <ul style="list-style-type: none">• 5 fixed incremental exercise test protocols (e.g. WHO)• 10 user-programmable protocols• manual load control• 4 fixed test protocols (e.g. PWC)• 10 user-programmable training protocols
Permitted Patient Weight	max. 160 kg (ergoselect 100 / ergoselect 150 / ergoselect 200) max. 200 kg (ergoselect 200 with stabilizer plate)
Saddle Height Adjustment	continuous, for patients between 120 cm and 210 cm ergoselect 100/150: manual adjustment of saddle height ergoselect 200: electrical adjustment of saddle height with digital readout
Handlebar Adjustment	for patient heights between 120 cm and 210 cm continuous handlebar adjustment over 360° ergoselect 100: rigid steering column ergoselect 150/200: height-adjustable steering column
Crank Length	170 mm (cranks with adjustable length are optional accessories)

Displays	LCD: 68 x 34 mm, 128 x 64 pixels (Control Terminal P) 115 x 88 mm, 320 x 240 pixels (Control Terminal K) additional LED display for speed (RPM)
Interfaces	PORT 1 (DSUB-9-pole): digital remote control RS232 by PC or ECG recorder, remote start of ECG recorder (optional) USB: digital remote control by PC (driver required)
Dimensions, Weight	ergoselect 100/150: length: 900 mm width: 420 mm (width of handlebar: approx. 535 mm) height: 900 mm - 1350 mm weight: approx. 74,5 kg / approx. 80 kg ergoselect 200: length: 900 mm width: 460 mm (width of handlebar: approx. 535 mm) height: 900 mm - 1350 mm weight: approx. 67 kg
Safety Standards	DIN EN 60601-1, DIN EN 60601-1-2, DIN VDE 0750-238
Protection class/degree of protection	II  / B (Ergometer) BF (Blood pressure cuff) BF (SpO ₂ sensor)
MDD Classification	class IIa to 93/42 EEC
RF Emission	class B to DIN EN 55011 / 5.0 DIN EN 60601-1-2
Environment	operation: temperature: +10 to +40 °C (50 to 104 °F) rel. humidity: 30 to 75%, no condensation atmospheric pressure: 800 to 1060 hPa transport and storage: temperature: -20 to +70 °C (-40 to +158 °F) rel. humidity: 10 to 95%, no condensation atmospheric pressure: 500 to 1060 hPa

BLOOD PRESSURE MODULE

Measuring Method	auscultatory method, oscillometric; for resting BP, the results from both measurements are compared for plausibility
Measuring Range	systolic pressure: 40 to 280 mmHg diastolic pressure: 40 to 280 mmHg pulse rate: 35 to 230 P/min

Measurement Error, systematic	systole: +/- 3 mmHg diastole: +/- 3 mmHg (temperature: +10 ... +40 °C)
Standard deviation (clinical trial)	systole / diastole: 7 mmHg (max.)
Inflation Pressure	300 mmHg max.; during inflation the inflation pressure automatically adapts to patient's BP
Inflation Rate	between approx. 6 seconds (to 140 mmHg) and approx. 18 seconds (to 300 mmHg)
Max. Cuff Pressure	300 mmHg
Cuff Deflation Method	pulse-dependent deflation rate approx. 3 mmHg/beat or approx. 3 mmHg/s
Calibration	calibration with external pressure meter
Artifact Rejection	automatic artifact rejection and comparison of the resting BP readings from both methods for plausibility

SpO₂ MODULE

FUNCTIONAL MEASUREMENT RANGE

SpO₂	0 – 100%
Pulse Rate	Standard Mode: 30 – 240 bpm;
Perfusion Index	OEM III: 0.1 – 20 % (no motion)

ACCURACY

SpO₂⁶	0 – 100%	70 – 100%: $A_{rms} \leq 2\%$ (no motion, incl. low perfusion ³) ^{1, 4} 60 – 80%: $A_{rms} \leq 2.5\%$ (no motion, incl. low perfusion ³) ^{1, 4} 70 – 100%: $A_{rms} \leq 3\%$ (motion condition) ² < 60 %: unspecified
Pulse Rate	Standard Mode: 30 – 240 bpm:	$A_{rms} \leq 2$ bpm (no motion, incl. low perfusion ³) ⁵ $A_{rms} \leq 3$ bpm (motion condition ²)

- 1) Pulse oximeter measurements are statistically distributed. A_{rms} accuracy is a statistical calculation of the differences between device measurements and reference measurements. Approximately two-thirds of device measurements are expected to fall within $\pm A_{rms}$ of the reference measurements.
- 2) Tested with all Fluke Index II Oximeter tester motion patterns with pattern specific motion frequency of 0.5Hz to 6Hz at perfusion PI: 0.65% to 5% including non-repetitive motion and motion repeating every 0.5Hz.
- 3) Tested with Fluke ProSim 8 Oximeter tester at infrared percentage modulation PI: 0.7% to 0.1%.
- 4) Applies to reusable SMARTsat® sensors, refer to sensor instructions for use for sensor specific accuracy claims. SpO₂ accuracy is validated by clinical accuracy studies on healthy adult male and female test subjects of age 21 to 32 with skin pigmentation ranging from light to dark over the specified functional oxygen saturation range.
- 5) Pulse rate accuracy was verified by simulated bench tests with Fluke ProSim 8 Oximeter tester to ensure that the entire range was verified.
- 6) Arterial functional oxygen saturation

RESPONSE TIME

Parameter	Specification
Display of first value	The time until the first value is displayed after application depends on the measurement conditions (perfusion, motion artifacts) and is in the following range: SpO ₂ : 3 to 7 s; Puls Rate: 5 to 8 s.
Data update period	Typically, the displayed data update period is 1 s. The data update is delayed in case no new valid data is available, e.g. due to excessive signal distortion. The longest data update period is 28 s.
Response time mode Standard (default)	Motion tolerance performance Motion resistant
	Average response time SpO ₂ : 8 sec. Puls rate (bpm): 10 sec.

EXERCISE TEST PROTOCOLS

Protocol	initial load [W]	time in stage [min]	load increment [W]	recovery load [W]	recovery time [min]
1. WHO	25	2	25	25	99
2. BAL	50	3	50	25	99
3. Hollmann	30	3	40	25	99
4. STD France	30	3	30	25	99
5. Standard	20	1	25	25	99
6. - 15. (user-programmable)	25	2	25	25	99
Adjustment Range	20 - 100	1 - 30	1 - 400	20 - 100 (*)	1 - 99

(*) With Control Terminal P, the recovery load is fixed at 25 W.

TEST PROTOCOLS (CONTROL TERMINAL K ONLY)

Protocol	initial load [W]	duration [sec]	load increment [W]	time in stage [sec]	recovery load [W]	recovery time [min]
ramping protocol	0	120	25	10	25	99
PWC-130 (*)	25	0	25	120	25	99
PWC-150 (*)	50	0	25	120	25	99
PWC-170 (*)	50	0	50	120	25	99

(*) The program advances to the recovery phase as soon as the target heart rate (130/150/170) is reached.

FAMILY OF CHARACTERISTICS OF THE BRAKING TORQUE CONTROL RANGE

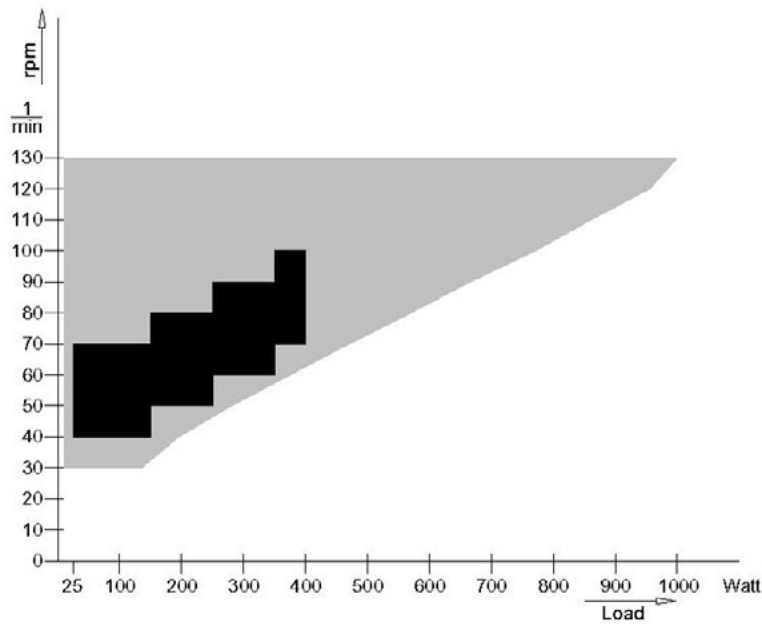

black: speed-independent range to DIN VDE 0750-0238
black + grey: speed-independent range of the ergoselect ergometer

FAMILY OF CHARACTERISTICS OF THE LOAD PERIODS ACCORDING TO IEC 60601-1

Watt	0-20	20-40	40-60	60-80	80-100	100-120	120-140	140-160	160-180	180-200	200-220	220-240
999	14	28	6	40	6	40	6	40	6	40	6	
900	18	28	7	36	7	36	7	36	7	36	7	
800	23	28	9	32	9	32	9	32	9	32	9	
700	29	28	11	29	11	29	11	29	11	29	11	
600	35	28	14	28	14	28	14	28	14	28	14	14
500	48	28	19	28	19	28	19	28	19	28	19	
400	72	28	26	28	26	28	26	28	26	28	26	
350	99	28	38	28	38	28	38	28	38	28	38	
300	∞											

Under permanent load, the load periods and pauses (white) shall be observed.

ELECTROMAGNETIC COMPATIBILITY

EN 60601-1-2

Changes or modifications to this system not expressly approved by ergoline could cause EMC issues with this or other equipment.

This system is designed to comply with applicable regulations regarding EMC.

Its compliance with these requirements has been verified. It needs to be installed and put into service according to the EMC information stated as follows.



WARNING

- RF Interference •

Use of portable telephones or other radio frequency (RF) emitting equipment near the system may cause unexpected or adverse operation.



CAUTION

- Equipment Malfunction •

The equipment or system should not be used adjacent to, or stacked with, other equipment. If adjacent or stacked use is necessary, the equipment or system should be tested to verify normal operation in the configuration in which it is being used.

GUIDANCE AND MANUFACTURER'S DECLARATION – ELECTROMAGNETIC EMISSIONS

The ergoselect ergometer is intended for use in the electromagnetic environment specified below. It is the responsibility of the customer or user to ensure that the ergoselect ergometer is used in such an environment.

Emissions Test	Compliance	Electromagnetic Environment – Guidance
RF emissions to EN 55011	Group 1	The ergoselect ergometer uses RF energy only for its internal function. Therefore, its RF emissions are very low and are not likely to cause any interference in nearby electronic equipment.
RF emissions to EN 55011	Class B	The ergoselect ergometer is suitable for use in all establishments, including domestic and those directly connected to the public low-voltage power supply network that supplies buildings used for domestic purposes.
Harmonic emissions to EN 61000-3-2	Class A	
Voltage fluctuations/flicker emissions to EN 61000-3-3	Complies	

GUIDANCE AND MANUFACTURER'S DECLARATION – ELECTROMAGNETIC IMMUNITY

The ergoselect ergometer is intended for use in the electromagnetic environment specified below. It is the responsibility of the customer or user to ensure that the ergoselect ergometer is used in such an environment.

Immunity Test	IEC 60601 Test Level	Compliance Level	Electromagnetic Environment – Guidance
Electrostatic discharge (ESD) to EN 61000-4-2	± 6 kV contact ± 8 kV air	± 6 kV ± 8 kV	Floors should be wood, concrete or ceramic tile. If floors are covered with synthetic material, the relative humidity should be at least 30%.
Electrical fast transient/burst to EN 61000-4-4	± 2 kV for power supply lines ± 1 kV for input and output lines	± 2 kV passed	Mains power should be that of a typical commercial or hospital environment.
Surge to EN 61000-4-5	± 1 kV differential mode ± 2 kV common mode	± 1 kV N/A	Mains power should be that of a typical commercial or hospital environment.
Voltage dips, short interruptions and voltage variations on power supply input lines to EN 61000-4-11	< 5 % UT (> 95 % dip in UT) for 0.5 cycles 40 % UT (60 % dip in UT) for 5 cycles 70 % UT (30 % dip in UT) for 25 cycles < 5 % UT (> 95 % dip in UT) for 5 s	< 5 % UT 40 % UT 70 % UT < 5 % UT	Mains power should be that of a typical commercial or hospital environment. If the user of the ergoselect ergometer requires continued operation during power mains interruptions, it is recommended that the ergoselect ergometer be powered from an uninterruptible power supply or a battery.
Power frequency (50/60 Hz) magnetic field to EN 61000-4-8	3 A/m	passed	Power frequency magnetic fields should be at levels characteristic of a typical location in a typical commercial or hospital environment. The ergoselect ergometer has no components susceptible to magnetic fields.

NOTE: UT is the a.c. mains voltage prior to application of the test level.

GUIDANCE AND MANUFACTURER'S DECLARATION – ELECTROMAGNETIC IMMUNITY

The ergoselect ergometer is intended for use in the electromagnetic environment specified below. It is the responsibility of the customer or user to ensure that the ergoselect ergometer is used in such an environment.

Immunity Test	IEC 60601 Test Level	Compliance Level	Electromagnetic Environment – Guidance
Conducted RF to EN 61000-4-6	3 Vrms 150 kHz to 80 MHz	3 V	<p>Portable and mobile RF communications equipment should be used no closer to any part of the ergoselect ergometer, including cables, than the recommended separation distance calculated from the equation applicable to the frequency of the transmitter.</p> <p>Recommended separation distance: $d = 1.2 \sqrt{P}$ $d = 1.2 \sqrt{P}$ for 80 MHz to 800 MHz $d = 2.3 \sqrt{P}$ for 800 MHz to 2.5 GHz</p> <p>where P is the rated output power rating of the transmitter in watts (W) according to the transmitter manufacturer and d is the recommended separation distance in meters (m).</p> <p>Field strengths from fixed RF transmitters, as determined by an electromagnetic site survey (a), should be less than the compliance level in each frequency range (b).</p> <p>Interference may occur in the vicinity of equipment marked with the following symbol</p> <div style="text-align: center;">  </div>
Radiated RF to EN 61000-4-3	3 V/m 80 MHz to 2.5 GHz	3 V/m	

NOTE 1: At 80 MHz and 800 MHz, the higher frequency range applies.

NOTE 2: These guidelines may not apply in all situations. Electromagnetic propagation is affected by absorption and reflection from structures, objects, and people.

(a) Field strengths from fixed transmitters, such as base stations for radio (cellular/cordless) telephones and land mobile radio, AM and FM radio broadcast and TV broadcast cannot be predicted theoretically with accuracy. To assess the electromagnetic environment due to fixed RF transmitters, an electromagnetic site survey should be considered. If the measured field strength in the location in which the ergoselect ergometer is used exceeds the applicable RF compliance level above, the ergoselect ergometer should be observed to verify normal operation. If abnormal performance is observed, additional measures may be necessary, such as re-orienting or relocating the ergoselect ergometer.

(b) Over the frequency range from 150 kHz to 80 MHz, field strengths should be less than 3 V/m.

**RECOMMENDED SEPARATION DISTANCES BETWEEN PORTABLE AND
MOBILE RF COMMUNICATIONS EQUIPMENT AND THE ERGOSELECT ERGOMETER**

The ergoselect ergometer is intended for use in the electromagnetic environment in which radiated RF disturbances are controlled. The customer or the user of the ergoselect ergometer can help prevent electromagnetic interference by maintaining a minimum distance between portable and mobile RF communications equipment (transmitters) and the ergoselect ergometer as recommended below, according to the maximum output power of the communications equipment.

Rated Maximum Output Power of Transmitter [W]	Separation Distance According to Frequency of Transmitter [m]		
	150 kHz to 80 MHz $d = 1.2 \sqrt{P}$	80 MHz to 800 MHz $d = 1.2 \sqrt{P}$	800 MHz to 2.5 GHz $d = 2.3 \sqrt{P}$
0.01	0.12	0.12	0.23
0.1	0.37	0.37	0.74
1	1.17	1.17	2.33
10	3.7	3.7	7.37
100	11.7	11.7	23.3

For transmitters rated at a maximum output power not listed above, the recommended separation distance d in meters (m) can be estimated using the equation applicable to the frequency of the transmitter, where P is the maximum output power rating of the transmitter in watts (W) according to the transmitter manufacturer.

NOTE 1: At 80 MHz and 800 MHz, the higher frequency range applies.

NOTE 2: These guidelines may not apply in all situations. Electromagnetic propagation is affected by absorption and reflection from structures, objects, and people.

ergoline
MOVING TO HEALTH

ergoline GmbH
Lindenstraße 5
72475 Bitz
Germany

Tel.: +49-(0) 7431 98 94 - 0
Fax: +49-(0) 7431 98 94 - 128
e-mail: info@ergoline.com
http: www.ergoline.com